

GAC-MAC-CSPG-CSSS  
**HALIFAX 2005**  
*Building Bridges—across science, through time, around the world*



## FIELD TRIP A4

Structural geology and vein arrays of lode  
gold deposits, Meguma terrane, Nova Scotia

*Rick Horne*



Geological Association of Canada  
Mineralogical Association of Canada - Canadian Society of Petroleum  
Geologists - Canadian Society of Soil Sciences  
Joint Meeting - Halifax, May 2005

Field Trip A4

**Structural geology and vein arrays of lode gold deposits, Meguma  
terrane, Nova Scotia**

Rick Horne

*Nova Scotia Department of Natural Resources, P.O. Box 698  
Halifax, Nova Scotia, Canada B3J 2T9*

© Atlantic Geoscience Society

Department of Earth Sciences  
Dalhousie University  
Halifax, Nova Scotia, Canada B3H 3J5

ISBN 0-9737981-2-2  
AGS Special Publication Number 23

Field Trip FT-A4

Structural Geology and Vein Arrays of Lode Gold Deposits, Meguma Terrane, Nova Scotia.

By

Rick Horne  
Nova Scotia Department of Natural Resources  
Halifax, Nova Scotia  
Canada, B3J 2T9  
[rjhorne@gov.ns.ca](mailto:rjhorne@gov.ns.ca)

GAC/MAC/CSPG/CSSS Joint Annual Meeting, Halifax, Nova Scotia

# Structural Geology and Vein Arrays of Meguma Lode Gold Deposits, Meguma Terrane, Nova Scotia.

## Table of Contents

### SAFETY

#### INTRODUCTION:

- Introduction
- Geological Setting
- Fold Development

#### Meguma Lode Gold Deposits

- Setting,
- Vein arrays
- A general model

### ITINERARY

Pre trip: Overview talk on Meguma Lode Gold Deposits (primer for the field trip) the evening of May 13<sup>th</sup>. This will be dependent on interest and all participants registered for the field trip will be contacted by e-mail in advance.

#### Day 1:

- Leave Halifax 6am
- Stop 1: Ovens Anticline, Rose Bay
- Stop 2: Lunenburg (lunch)
- Stop 3: Uniacke

#### Day 2:

- Leave Halifax 8am
- Stop 1: Mooseland Gold District, Azure Resources Mine
- Stop 2: Dufferin Gold District, Azure Resources Mine

## Locations of Field Stops:

### Day 1, Stop 1, Ovens Anticline

- From Halifax take Highway 103 west to Exit 11 (Blockhouse), close to an hour drive.
- At Exit 11 head south on Route 324, through Blockhouse to a stop sign just past Lilydale, approximately 9.25 kilometres from Blockhouse.
- Turn west (right) on Route 332 and follow for approximately 10.5 kilometres where there is a sign for South Feltzen and the Ovens.
- Turn east (left) and follow this road for just over 2 kilometres where there is sign for the Ovens Natural Park.
- Turn right onto a dirt road and follow to the for just over 1 kilometre. At this point you should be able to see the ocean and there is a sharp turn to the left. Park here. There is a lane on the right which you can walk (with permission of the residents). A few hundred metres along this road you can access the shoreline, which will put you at the east end of the Rose Bay section described.

### Day 1, Stop 2, Uniacke

- From Halifax take Highway 101 north to the Uniacke Exit.
- At the intersection with Route 1, at the stop sign, head north (left).
- Look for a sign for the Etter Road on the right, and continue for another 2.2 kilometres.
- The Highway #1 pit occurs on the east side on the road here.
- Head back (south) to Etter Road and turn east. A few hundred metres along Etter Road there is sign for South Uniacke.
- Follow the South Uniacke Road until it crosses a railway track.
- Immediately after the tracks take a lane to the north.
- This lane leads to the South Uniacke pit location.

### Day 2, Stop 1, Mooseland Gold District

- From Dartmouth, take Highway 7 east and continue to Tangier.
- Just east of Tangier turn north on the Mooseland Road.
- Follow the Mooseland Road for approximately 19 kilometres and look for the entrance for the Azure, Mooseland Project.
- The portal and exposed hinge area occur on the south end of the mine site.

### Day 2, Stop 2, Dufferin Gold Mine

- From Mooseland head south to Highway 7 and proceed east through Sheet Harbour.
- At Port Dufferin turn north on the Dufferin Mines Road.
- A few kilometers up the road veer to the left on the Mines Road and follow to the mine site.

## SAFETY

During the two days of this field trip we will visit sea-side cliffs, roadside outcrops and underground mine operations, and safety is of foremost concern. *The field trip leader will attempt to ensure a safe environment at all time, but individual safety requires the concern of each participant, so please take precaution during field trip activities.* The weather conditions in Nova Scotia are unpredictable. Although mid-May can be pleasant, you should have clothing available for possible cold and wet conditions. A variety of ground conditions will be encountered and boots (preferably safety) with good traction are essential.

Our visits to the Ovens area will involve traverses along the Atlantic coast, where wet and seaweed-covered rocks make for slippery conditions. Wear good boots and take caution in these areas. There are cliffs and falling rocks are a possibility so please stay back from high cliffs. Although some of the cliffs are low, please do not climb. The outcrop consists largely of slate, which can be more than sharp enough to cut through skin. During a field trip here a few years ago a participant slipped and cut a large gash in the back of her leg on a sharp piece of slate, ending the trip before it began. Better to take a little longer than to miss the day completely. Access to the Ovens Anticline in Rose Bay is dependant on the tide, with the western part of the section inaccessible at high tide. Our visit will begin at low tide, with a rising tide during our time on this section and therefore it is critical that participants stay as a group and follow the trip leader to prevent anyone from becoming trapped.

On day two we will visits underground mining operations. These are industrial sites and safety equipment is required at all times, including safety boots (ones with safety toes), hard hats and goggles. Hard hats and goggles will be provided, however it is hoped that participants will have safety boots (a limited number of boots will be available). Mine lamps and self rescuers will be provided for the underground trip. These sites may be operating during our visit and we will likely encounter moving vehicles. The most important aspect of safety is to stay with the trip leader and to follow his instructions before proceeding within the mine.

## INTRODUCTION

Over sixty Meguma Lode Gold Deposits (MLGD) operated at one time or another, mainly during then latter 1800's and early 1900's. These deposits consist of auriferous veins hosted by the Meguma Group, the dominant unit of the Meguma Terrane of southern Nova Scotia (Fig. 1). A number of diverse genetic models have been proposed for MLGD, resulting in much debate regarding the formation of these deposits. A comprehensive review of these theories can be found in Henderson et al. (1992), a guidebook for a similar field trip from the GAC 1992 meeting in Wolfville. An overview of the principal hypothesis would include: (i) a *syn-sedimentary* origin proposed by Haynes (1986), who considered the veins to represent hydrothermal hot springs deposits; (ii) a *magmatic origin* was proposed by Newhouse (1936). (iii) A *metamorphic origin* for the veins was proposed by Graves and Zentilli (1982), Henderson (1983), Henderson and Henderson (1986; 1990) and Henderson et al. (1986, 1988), with elevated (supralithostatic) fluid pressure during regional deformation-metamorphism resulting in hydraulic fracturing recorded by laminated (crack seal) bedding-parallel veins. These hypotheses considered vein formation to predate regional folding. (iv) Several syn-folding models have been proposed, which either generally, or specifically, follow a *saddle-reef type* model (Faribault, 1899; 1913; Mawer, 1985; 1987; Keppie, 1976; Horne and Culshaw, 2001; Kontak et al. (1990).

The latter two hypothesis have be given the most recent consideration, with the critical point being whether the veins constituting MLGD predate folding or are syn-folding in origin. For the pre-folding hypothesis, the issue is restricted to the interpretation of bedding-concordant veins, which proponents consider the dominant auriferous veins, to predate 'late', unrelated discordant veins. The relative age of bedding-concordant veins to folding is constrained by their relationship to macro- to micro-scale elements of regional folds and we will evaluate these relationships during this field trip.

Following is a general discussion of the regional setting and character of folds hosting MLGD and a general discussion of the vein arrays which define them. These features will be used to constrain a general model for MLGD. Features of regional folds and vein arrays discussed in this introduction will be highlighted at the field stops, allowing for observation and discussion of the principal elements which constrain interpretations of a model for the development of MLGD vein arrays.

### **Geological Setting:**

The Meguma Terrane is the most outboard terrane of the Appalachians and separated from the Avalon Terrane to the north by the Cobequid Chedabucto Fault System (Fig. 1). The Meguma Terrane is dominated by the Cambrian-Ordovician Meguma Group, consisting of the lower metasandstone-dominated Goldenville Formation and overlying slate-dominated Halifax Formation, which is overlain by Early Silurian-Lower Devonian metasedimentary and metavolcanic units (Fig. 1). This sequence was folded into kilometre-scale folds (Fig. 1) during the middle Devonian Acadian Orogeny. Late Devonian plutons truncate regional folds and related cleavage, however subtle regional structural fabrics within the South Mountain Batholith suggest late syntectonic emplacement (Benn et al., 1997; Horne et al., 1992). A long history of post-Acadian deformation of the Meguma Terrane includes: fold tightening (Horne and Culshaw, 2001); Carboniferous age shear zones overprinting Acadian fabrics in southwest Meguma

Terrane (Culshaw and Liesa, 1997); shortening of Carboniferous cover rocks, and even late- to post-Cretaceous faulting (Stea and Pullan, 2001).

### **Regional fold development**

MLGD are hosted by regional folds and an understanding of fold development is critical to evaluating the formation of veins.

The Meguma Group is folded into large-scale regional folds, with kilometre-scale wavelengths and axial traces that extend tens to hundreds of kilometres (Fig. 1). Map patterns (Fig. 1) confirm folds are generally horizontal, and apparently cylindrical over long distances, although they locally plunge west and east with non-cylindrical geometries. In cross section, folds are characterized by box and chevron geometries which are organized as large-scale anticlinorium and synclinorium (Fig. 1). Box folds are characterized by steep (vertical) limbs and gently folded median segments and axial planes with no consistent vergence (Fig. 1). This fold style is characteristic of a folded multilayered sequence (eg. the Goldenville Formation) where there is a high viscosity contrast between layers and a low thickness ratio of competent to incompetent layers (i.e. Model F folds of Ramsay and Huber, 1987). Such folds develop with little initial layer-parallel shortening (Ramsay and Huber, 1987) and modeling shows box and chevron fold development involves shape changes during progression from early box folds to chevrons, in which hinge migration is clearly important (e.g.; Cobbold et al. 1971; Fowler and Winsor, 1996).

Box and chevron folds develop as flexural folds, where strain is accommodated primarily by layer-parallel shear (flexural shear) on fold limbs. Shear strain is largely confined to incompetent layers, where it may be distributed homogeneously across the layer (flexural flow) or be restricted to discrete movement horizons (flexural-slip) (Fig. 2a), and results in the development of numerous minor structures (Figs. 2b). The *rate* of flexural shear strain increases with increasing limb dip (Fig. 2d), and the majority of flexural-shear structures form only after significant limb dip is achieved (Ramsay, 1974). An array of “accommodation structures” (Ramsay, 1974) may develop in hinge zones as a result of variation in competent layer thickness, including hinge thrusts and bulbous hinges, and hinge dilatancy may result in saddle reef formation. Veins developed within structures formed during folding produce a family of veins sets which are geometrically related to the fold (Fig. 2b).

Previous studies confirm that flexural folding was important in fold development in the Meguma Group, documenting many of the structures illustrated in Fig. 2b (Henderson et al., 1986; Horne and Culshaw, 2001, Faribault, 1899, 1913; Armstrong, 1937; Smith, 1976; Keppie, 1976; Horne and Jodrey, 2002). Henderson et al. (1986) proposed that (flexural) folding was predated by homogeneous layer-parallel shortening (~50%) and cleavage development, with strain mainly accommodated by volume loss (Wright and Henderson, 1992). These interpretations were based principally on observations that paleo-plumblines were invariably within the cleavage plane, strain measured on the bedding plane was similar regardless of limb dip, and the lack of features demonstrating extension accompanying cleavage development. Shortening values were determined from folded layer-parallel veins, aspect ratios of sand volcanoes and the relationship of paired worm borrows to cleavage (Henderson et. al., 1986; Wright and Henderson, 1992).

The interpretation that folded bedding-parallel veins reflect layer-parallel shortening predating regional fold development is critical to the hypothesis that MLGD predate regional



Fig 1: Simplified geology map of the Meguma Terrane. Cross sections are after Fletcher and Faribault (1911) and illustrate the style of folds in the Meguma Group and the structural location of MLGD within fold hinges. SMB= South Mountain Batholith; MB=Musquodoboit Batholith.

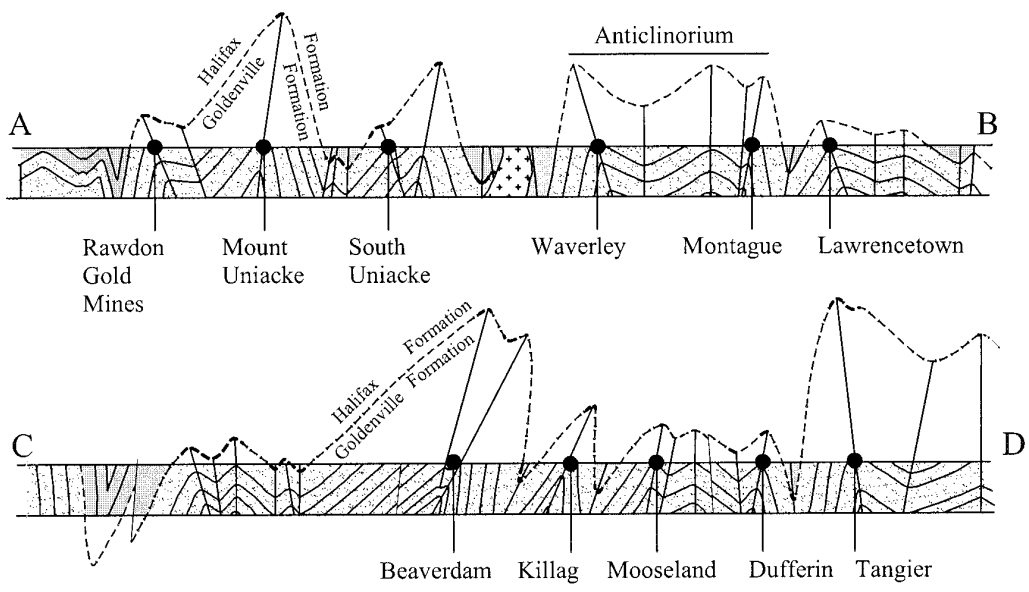
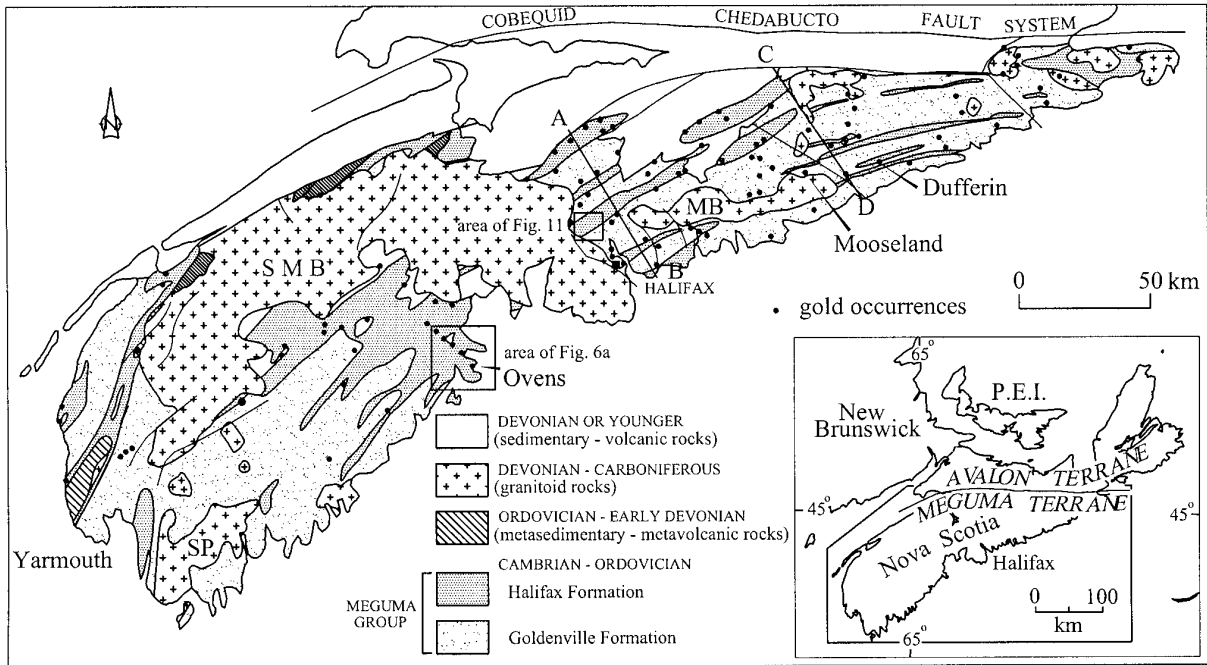

Fig 2: (a) Simplified model of flexural flow and flexural slip folding. (b) Diagram showing minor structures and veins developed in flexural folds (after Tanner, 1989) (c) Sketch showing shear strain and angular shear strain on a fold limb. (d) Graph of the relationship of flexural shear strain to limb dip, showing how the rate of shear strain for changing limb dip increases with limb dip.

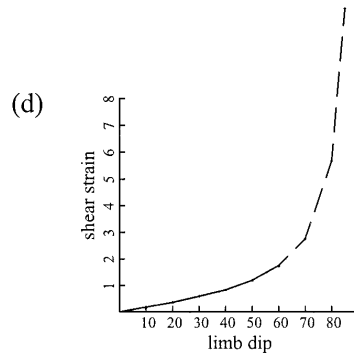
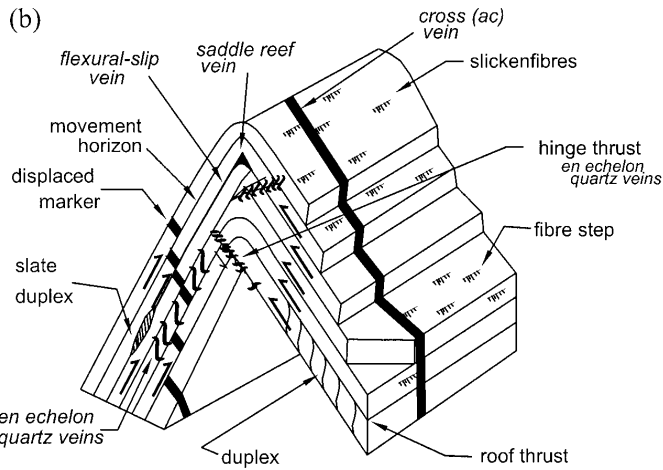
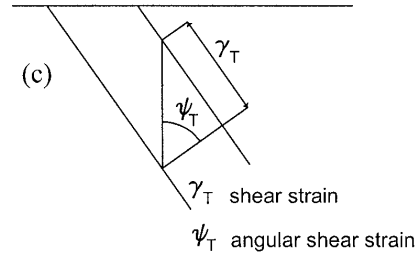
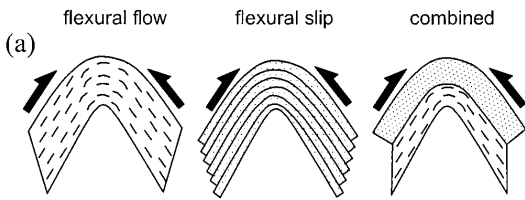
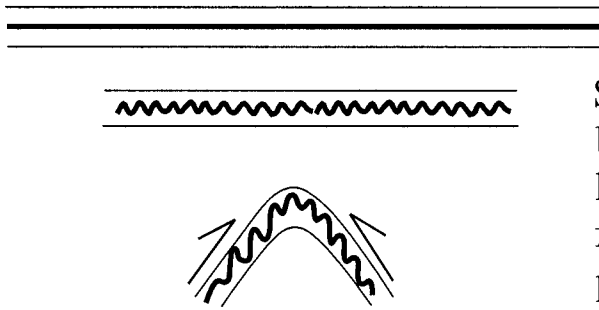

Fig. 3 Schematic diagrams illustrating the relationship of folded bedding-concordant veins to regional folds. In (a), bedding-concordant veins developed prior to regional deformation, were subjected to layer-parallel shortening and buckled. Later regional fold development resulted in a parasitic arrangement of folded veins. In (b), bedding-concordant veins formed as flexural-slip veins, with buckling restricted to fold hinges where the veins remained in a favorable orientation for buckling. Veins on the limbs were not buckled, although hinge migration could locally result in buckled veins on fold limbs.

(a)



Sequence of:  
bedding-parallel vein formation,  
layer-parallel shortening  
followed by folding, resulting in  
parasitic folds

(b)

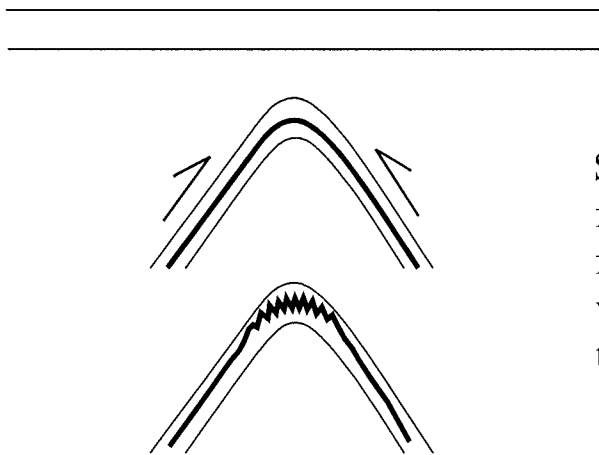

Sequence of:  
folding with development of  
flexural-slip bedding-parallel  
veins, layer-parallel buckling in  
the hinge

folding (see above). Pre-folding layer-parallel shortening implies a parasitic relationship of minor folds, with continuity of buckle folds on regional fold limbs (Fig. 3a). However, several workers have documented a *restricted distribution* of buckled bedding-parallel veins to *fold hinges* (Faribault, 1913; Mawer, 1987; Williams and Hy, 1990; Kontak et. al., 1990; Horne and Culshaw, 2001; Horne et al., 2004) suggesting layer-parallel shortening occurred after significant fold development; when shortening on limbs was not favorable (Fig. 3b). This is supported by a study of layer-parallel shortening recorded by cotecule layers, which showed significant variability in shortening values; shortening was greater in fold hinges than on limbs, and locally cotecule layers are unbuckled on fold limbs (show no shortening) (Young, 2000). Young (2000) interpreted layer-parallel shorting variability with respect to box-chevron fold development. Early formed limbs of box folds record no layer-parallel shortening and fold shape changes and hinge migration during box-chevron fold development varies the time that box fold hinges (median segments) remain in a favorable orientation for shortening (see Day 1, Uniacke Stop below). We will see good evidence of the restriction of layer-parallel shortening to fold hinges on this field trip.

## **MEGUMA GROUP LODE GOLD DEPOSITS**

### ***Introduction:***

MLGD comprise concentrations of auriferous quartz veins. The majority of the veins are stratabound and much attention has been given to bedding-concordant veins, in particular laminated bedding-concordant veins. Although each deposit presents its own unique features, in general MLGD show remarkable similarities, implying a single comprehensive model can explain their origin. The following section will provide a general review of the principal features of MLGD which will be utilized to constrain a general model.

### **GENERAL SETTING OF VEIN ARRAYS**

It is well recognized (undisputed) that MLGD are primarily localized in anticlinal hinge zones of regional folds, commonly in domes (Figs. 1, 4a) (Faribault, 1899; Malcolm, 1929). The distribution of veins within individual folds shows a systematic relationship with respect to fold geometry (Faribault, 1899; 1913; Malcolm, 1929). Generally, in tight chevrons, where both limbs are steep, veins occur on both limbs and across the hinge and saddle reef veins are common (Malcolm 1929; Keppie, 1976) (Figs. 4b). Where modified box folds defining anticlinorium occur, veins are concentrated on the steep limbs but are rare in the flat median segment of the fold (Fig. 4c). Vein arrays locally occur in minor folds on regional fold limbs where they show similar distribution with respect to the fold. The arrangement of vein arrays within folds suggests a structural control on their distribution, which may reflect higher flexural shear strain on steep limbs than on shallow limbs. An idealized box-chevron section with veins localized on steep limbs is shown in Figure 4d and compares well with the examples of MLGD.

### **VEIN ARRAYS**

Veins within MLGD have been classified in various ways, using elements of morphology (e.g., laminated, ribbon, massive, bull), mineralogy (e.g., pegmatoid, sulfide poor, silicate bearing, tourmaline), the relationship of veins to folds (stratabound, bedding-parallel, ac, angular, saddle reef, en echelon), and sometimes a combination of features (Henderson et al., 1986; Henderson and Henderson, 1986; Smith and Kontak, 1988; Williams and Hy, 1990; Sangster, 1990; Malcolm, 1929; Faribault, 1913) Additionally, some veins have been referred

Fig 4a: Map of the eastern Meguma Terrane showing the distribution of MLGD with respect to

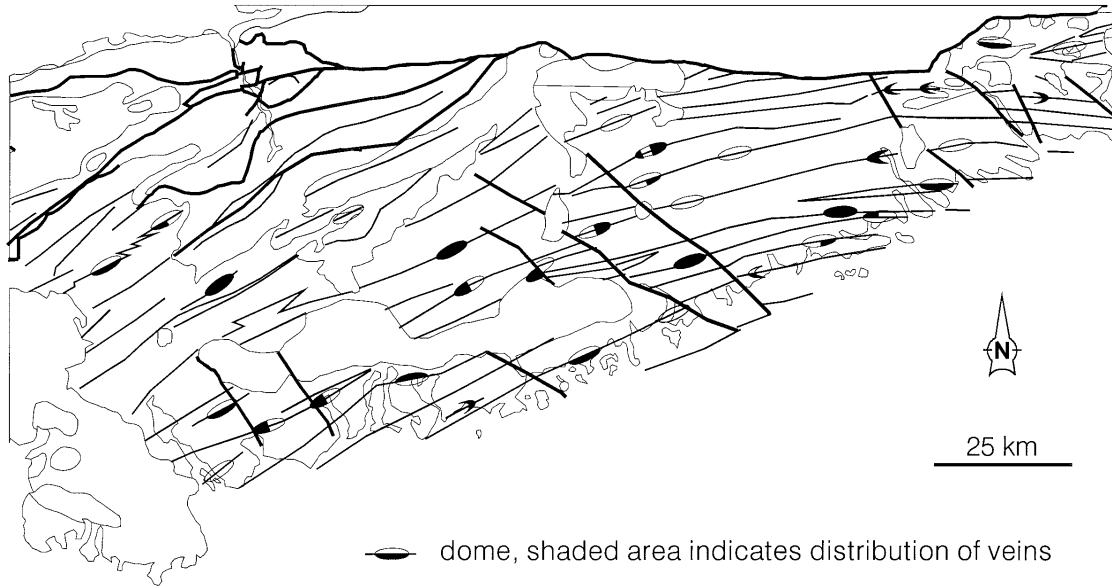

folds, in particular dome structures (after Fletcher and Faribault, 1911).

Fig. 4b: Cross section of the South Uniacke Gold District illustrating the distribution of bedding-concordant veins (heavy lines) with respect to the fold. Note veins on both limbs of the chevron fold on the right whereas veins occur only on the steep limb of the fold on the left.

### South Uniacke Gold District

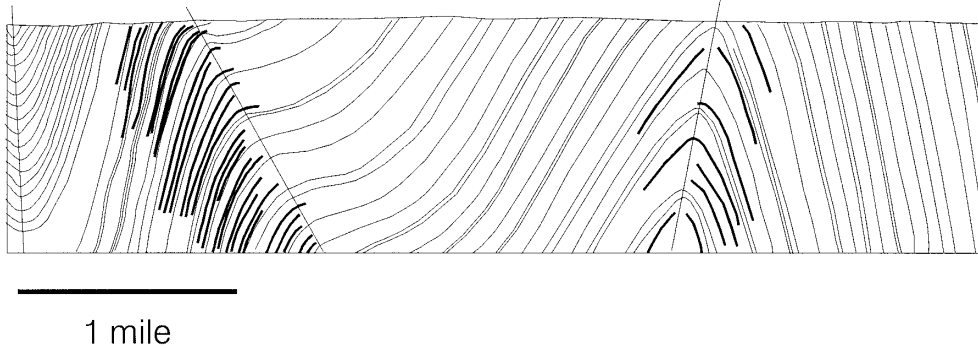

Figure 4c: Cross section showing the distribution of the Waverley and Montague gold districts on the north and south limbs of an anticlinorium (see cross section in Fig 1 for reference). Bedding-concordant veins at each district occur primarily on the steep limbs, which represent the limbs of the anticlinorium.

### Waverley Gold District

### Montague Gold District

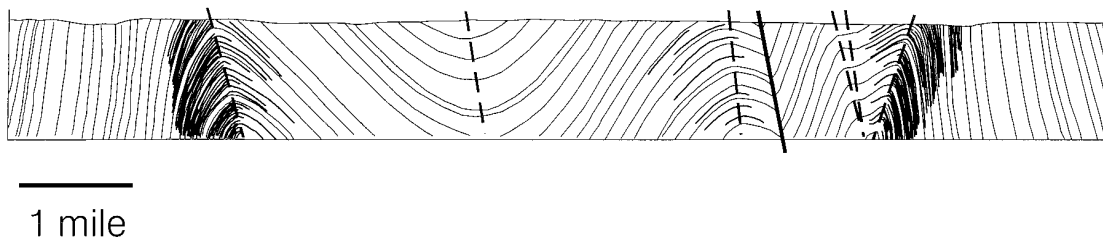
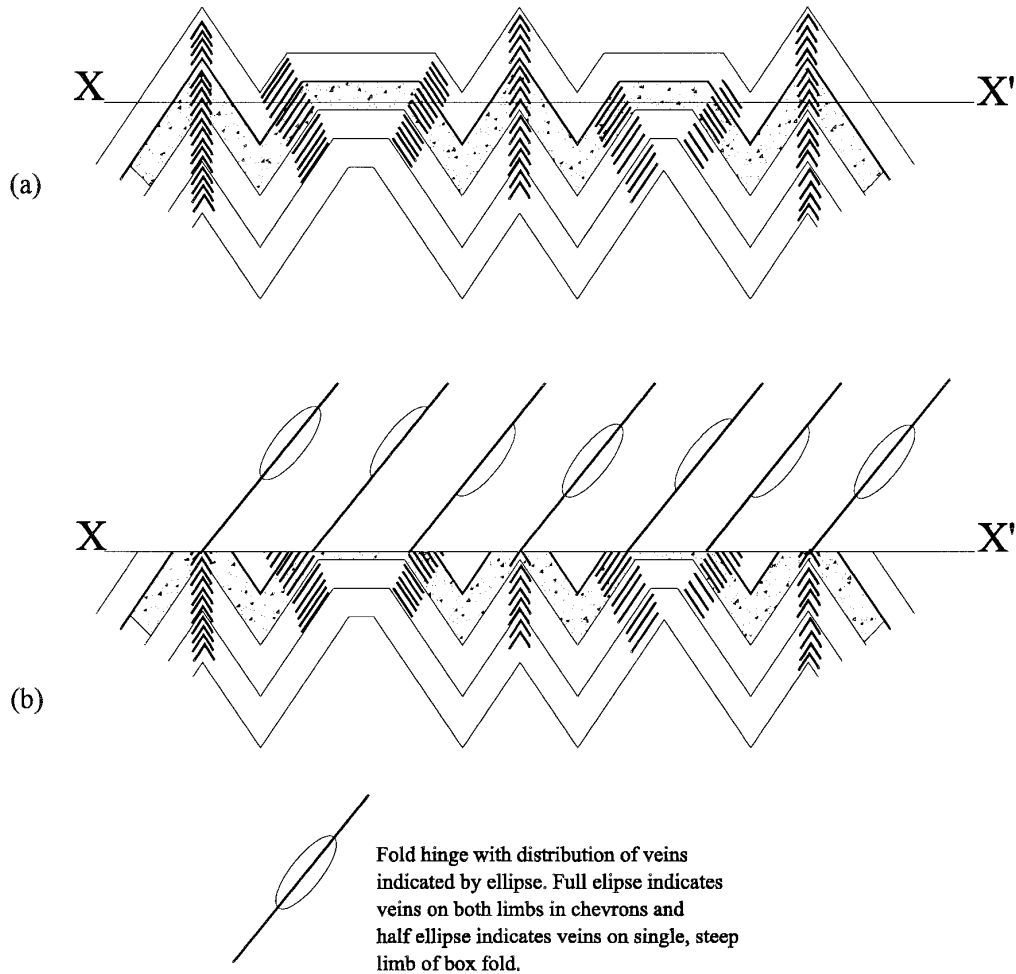

Fig. 4d: Idealized cross sections of box and chevron folds illustrating the expected distribution of bedding-concordant veins formed in structures related to flexural shear; i.e., on steep limbs where shear strain is high. Illustration b represents an eroded surface showing the plan view vein distribution. The vein distribution in this idealized model compares well with the distribution of veins with MLGD, as presented in Figs. 4a-c.



to with respect to their mechanism of formation (crack seal, replacement, shear) (Smith and Kontak, 1988) and veins of similar type (e.g. ac veins) have been subdivided as early or late (Williams and Hy, 1990). The above list clearly illustrates many vein types are present within MLGD. A review of literature and observations of the author suggest that the most appropriate (or the most useful) classification of veins is with respect to their geometric relationship to regional folds, recognizing that veins of various morphology and mineralogy may represent various vein sets. The principal vein sets of MLGD are illustrated in Figure 5a and described below.

### ***STRATABOUND VEINS:***

Stratabound veins, those confined to stratigraphic layers, are, with minor exception, restricted to slate/metasilstone layers. Several distinct vein types can be recognized and are described here.

### **Stratabound “laminated” bedding-parallel veins:**

Laminated bedding-parallel veins define a distinct class of bedding-concordant veins which are characterized by a laminated texture, including “ribbon” and “book textures” (McKinstry and Ohle, 1949). Perhaps because of their distinct character, these veins have been the focus of considerable previous work on MLGD, and interpretation of the formation of laminated veins has strongly influenced genetic models for MLGD (e.g. Henderson et al., 1990; Graves and Zentilli, 1982) and for similar veins in other gold deposits (e.g. Australia, Whales). The macro- and micro-structure of these veins have been interpreted to reflect a variety of vein-forming mechanisms, including **(1)** hydraulic extension fracturing prior to folding (Henderson et al. 1989; 1990; Graves and Zentilli, 1982; Fitches et al., 1990) **(2)** shear which is reverse of that expected for flexural slip and which occurred prior to fold development (Jessell and Gray, 1995) (after which time the veins were subjected to flexural shear strain?); **(3)** shear vein growth which is consistent with flexural slip (Fowler, 1996; Mawer, 1987); some workers have used the presence of laminated veins to denote flexural-slip movement horizons (e.g., Tanner, 1989; Fowler and Winsor 1997; Cosgrove, 1993); **(4)** wall rock replacement (Smith and Kontak, 1988).

Laminated veins are typically composite, with massive quartz cutting laminated areas and replacement of wall rock and early veins was almost certainly important in the resulting vein character. Laminated veins invariably occur in slate or metasilstone layers, commonly at the contact with overlying metasandstone beds. They are typically planar on fold limbs but may be buckled in fold hinges (Fig. 5a; Ovens, Mooseland, Dufferin stops below). Locally, these veins represent the down-dip extension of saddle-reef veins (Horne and Jodrey, 2002; Horne and Culshaw, 2001). These veins commonly occupy flexural-slip horizons defined by offset discordant veins, which predate the laminated veins (flexural-slip veins of Horne and Culshaw, 2001). Movement horizons commonly occur at the vein-wall rock contact (Horne and Jodrey; Horne and Culshaw 2001, Faribault, 1899). Laminations within veins are commonly characterized by striated slickensides oriented perpendicular to the fold hinge. These observations suggest that many laminated veins occupy flexural-slip movement horizons. This was the conclusion of Faribault (1899), who investigated more of these deposits than all those who have studied these deposits since. I suggest that the many features characterizing laminated veins reflect vein formation in active bedding-parallel flexural-slip movement horizons, where progressive vein formation included a combination of shear vein and extensional vein growth during flexural slip (slickensides), hydraulic fracturing resulting from high fluid pressure,

Figure 5: (a) Schematic diagram of the principal vein types in MLGD. (b) Diagram illustrating the formation of en echelon shear vein arrays during fold development. Veins initially are shortened during progressive shear, with significant shear resulting in boudinage of individual veins. (c) Diagram illustrating how shear strain recorded by en echelon veins is determined.

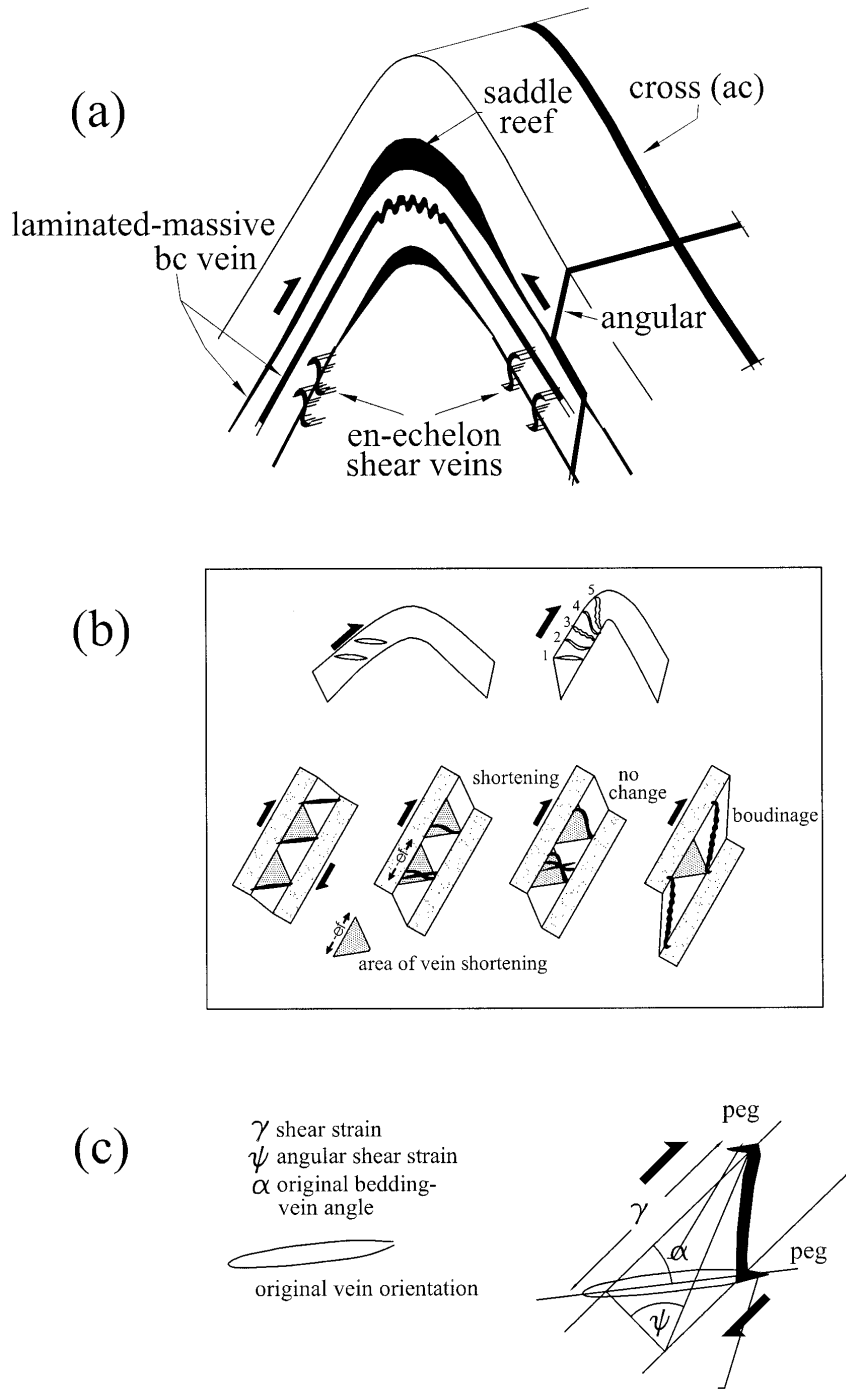



replacement and deformation of wall rock and vein material throughout the vein forming process. A similar interpretation was proposed for laminated veins in the Bendigo gold fields (Stone, 1937). This interpretation accounts for the general character of the veins at all scales, from geological setting to microstructure, and does not rely on new interpretations of poorly understood and relatively uncommon features (e.g; water sill hypothesis; Henderson et al., 1990).

#### **Stratabound en echelon vein arrays:**

En echelon shear vein (EESV) arrays (Ramsay, 1980) within slate or metasilstone intervals are a common component of many MLGD vein systems, and locally occur as isolated veins regionally (Henderson et al., 1986; Henderson and Henderson, 1983;1986; Henderson, 1993; Sangster, 1980; Jodrey, 2001; Horne and Jodrey, 2002; Henderson in Keppie et al. 1983). These veins exhibit sigmoidal shapes, with 'pinned' ends in competent sandstone and rotated (sheared) median segments within less competent slate or metasilstone (Fig. 5a). These veins record significant but variable shear and the median segment is commonly boudinaged as a result of rotation into the extensional field (Fig. 5b). The intersection of individual veins on bedding is parallel to the fold hinge (Fig. 5a) and the geometry of veins changes across the fold hinge such that they invariably indicate a reverse shear sense perpendicular to the fold hinge, and that they reflect flexural shear strain seems unequivocal.

#### **Stratabound Saddle Reef Veins:**

It is unclear how prevalent saddle-reef veins are within MLGD's, and their importance has been down played by some workers (e.g. Henderson and Henderson, 1987). The author has documented classic saddle reef veins at the Dufferin, Mooseland and Ovens districts (see stop descriptions below), Williams and Hy (1990) described saddle reef veins at Harrigan Cove and the tip of Taylors Head, and numerous references to saddle reef veins are made on the district maps of Faribault.

Saddle-reef veins occupy zones of dilation in fold hinges resulting from flexural-slip folding, and develop only after significant fold development (Ramsay, 1974). This is consistent with the observations made by Malcolm (1929) and Keppie (1976) that saddle reef veins are common in MLGD characterized by tight folds (interlimb angle is  $<45^\circ$ ). Many of the saddle veins referred to by Faribault on his district maps are characterized by veins which taper gradually down the fold limbs; e.g. Faribault (1913) describes the Dominion vein at the Waverley deposit to decrease from 40 centimeters at surface to a mere film of quartz by 150 metres. This gradual change in thickness may lead investigators to not regard these veins as saddle reefs. However, the shape of the saddle reef may be more a function of the fold wavelength than the process of formation. The amount of dilatancy created is a function of limb dip and the thickness/length ratio of competent layers and increases markedly with progressing folding (Ramsay, 1974; Ramsay and Huber, 1987). In the Meguma Group the thickness/length ratio is typically very small (much less than 0.02) and does not favour the formation of large saddle reefs. Indeed, the well developed saddle-reef veins in the Meguma Group occur in minor folds with relatively short wavelengths (e.g. Dufferin, Isaacs Harbour). In addition, many of the vein arrays of MLGD's are found on the steep limb of asymmetric box folds where saddle reefs would not be expected

#### **CROSS VEINS:**

Cross veins are discordant to bedding and are commonly roughly parallel to the ac plane of the fold (Fig. 5a)(ac veins; Henderson et al. 1986; Sangster, 1990; Smith and Kontak, 1988). Few studies have presented any systematic data on these veins. Abundant cross veins at the Ovens Gold

District (Day 1, Stop 1) form a conjugate set with a small acute angle where a pole to the plane bisecting the veins is parallel to the fold hinge (Horne and Culshaw, 2001). Cross veins measured during regional mapping at the east end of the Waverley Gold District parallel the ac plane (Horne et al. 1997). Some previous studies have suggested that cross veins are volumetrically insignificant within gold districts, and are regional in nature; i.e, not part of the gold-related vein array. However, my observations suggest that concentrations of cross veins are anomalous within MLGD (Horne and Culshaw, 2001; Horne et al. 1997; Horne and Jodrey, 2000), that they formed synchronous with stratabound veins (see field Ovens, Mooseland, Dufferin stops below) and can be auriferous. Indeed, cross veins were important gold producers in several MLGD (e.g., Brookfield, Leipsigate, Central Rawdon). Cross veins typically consist of massive quartz with textures suggestive of open space filling and thus record minor extension parallel to the fold hinge.

### ***ANGULAR VEINS:***

The term ‘angular vein’, or angulars, was applied by early workers (e.g. Faribault, 1899; Armstrong, 1937) to veins which branch off from bedding-parallel veins (Fig.5a). Their intersection with bedding varies between deposits but is typically consistent within any single deposit (Armstrong, 1937). These veins typically include bedding-parallel and discordant segments (Fig. 5a) and where they coincide with preexisting bedding-parallel veins they thicken them, and this overlap commonly is a zone of gold enrichment (ore shoot). Few examples of angular veins have been described in recent reports. Angulars intersect metasandstone beds at a high angle to bedding whereas they cut obliquely across slate layers (Malcolm 1927). As noted by Sangster (1990), angular veins resemble en echelon veins, which cut across stratigraphy, and they likely formed in response to bedding-parallel shear. The intersection of angulars with bedding is sometimes parallel to the fold hinge (like pins of en echelon veins), however, their geometry with respect to the fold is not always consistent with flexural folding (see Mooseland stop below).

## **DISCUSSION**

### **Relationship and abundance of veins - *Vein Arrays***

MLGD represent anomalous concentrations of auriferous quartz veins localized in the hinge region of regional folds. As outlined above, there are several vein types, however bedding-concordant veins, in particular laminated veins, have been considered by many as the dominant vein type, or at least the only important vein type, with respect to gold mineralization.

My observations (Horne, 1998; Horne and Culshaw, 2001; Horne and Jodrey, 2002; Horne et al., 1987; 2004), which we will see on this field trip, indicated that:

- (1) Concentrations of all veins types are highly anomalous within MLGD with respect regional vein concentrations.
- (2) There are mutual cross-cutting relationships between stratabound and cross veins indicating synchronous formation.
- (3) Bedding-concordant laminated and en echelon vein arrays represent down-limb extensions of saddle-reef veins.
- (4) All vein types can be auriferous and contain similar accessory mineralogy and common isotopic signatures.

These observations indicate that MLGD are characterized by an array of intimately (temporally and spatially) related vein types with a common origin and therefore an explanation of their development must accommodate all vein types. These relationships were established at the locations of this field trip and will be outlined during our stops.

### **Timing:**

The relative time of vein development is established with respect to regional deformation (folding). A pre-folding origin for laminated bedding-concordant veins was proposed by Henderson et al. (1986) and Zentilli and Graves (1982), based largely on the belief that buckling of these veins records layer-parallel shortening prior to regional fold development. However, as discussed in then introduction (regional fold development), the layer-parallel shortening represented by the veins is restricted to fold hinges and considered to represent syn-folding deformation. Notably, proponents of a pre-folding age for MLGD do not relate the buckled laminated veins with the development of other vein types. Considering the character of the whole vein array and the constraints imposed by the character of region fold development we are faced with these considerations:

(1) Fold development (box-chevron) involved hinge migration. That MLGD are invariably found in fold hinges implies they formed late in the fold history, post-dating any significant hinge migration. On a deposit scale, kinematics shown by en echelon veins, which clearly record the final increments of fold development, and flexural-slip (laminated) veins, systematically changes across the hinge, confirming the vein array post-dates any hinge migration.

(2) Bedding-concordant and discordant veins include cleaved fragments of wall rock, indicating post-cleavage vein development. Flexural-slip structures associated with vein formation are brittle and not overprinted by further deformation.

(3) The formation of saddle reef veins occurs only after significant fold development.

(4) The distribution of veins on steep limbs is consistent with the formation of flexural-shear structures, including veins, resulting from increasing shear strain at high limb dips.

(5) MLGD vein arrays show only moderate deformation. Discordant veins, which show mutual cross-cutting relations with stratabound veins, are undeformed to moderately folded.

These constraints support vein formation late in the fold history.

### **A general model:**

The character of MLGD as outlined in the previous sections can, in my opinion, only be readily explained by vein formation in a flexural shear environment. Studies that have argued MLGD developed prior to regional folding focused primarily on laminated bedding-parallel veins. Many interpretations have been suggested for the formation of laminated veins and their origin is equivocal. The restriction of buckle laminated bedding-parallel veins to fold hinges undermines the argument that this buckling represents layer-parallel shortening prior to regional fold development. MLGD consist of a *vein array* and the formation of all veins must be satisfied in a comprehensive model. En echelon veins are often not considered part of the vein arrays and have not been documented in many of the deposits. However the author has found en echelon veins to

be an essential part of the vein array at the Dufferin, Mooseland, Upper Seal Harbour and Forest Hills deposits and en echelon veins are shown in historical photos from Goldenville. Laminated veins at the Ovens and Dufferin deposits locally are the down limb extension of saddle reef veins and discordant (ac) veins have mutual cross-cutting relationships with stratabound veins. These observations require that a general model for MLGD provide an explanation for all vein sets.

The mechanism of saddle reef and en echelon vein formation is unequivocal and supports a flexural-shear origin for veins late in fold development. Bedding-parallel laminated veins are everywhere consistent with, and locally interpreted to record, flexural slip folding (e.g.; flexural-slip veins at the Ovens (see stop below). A flexural shear model provides a comprehensive explanation for MLGD veins arrays and is favored by the author. Of course, it's the objective of this field trip to provide an opportunity to exchange ideas.

### **Flexural Shear Strain:**

Flexural folding is considered the dominant fold mechanism in the formation of folds in the Meguma Group, consistent with their box-chevron character. Many of the veins and associated structures clearly record flexural-shear strain late in fold development. However, the amount of flexural shear strain is difficult to determine in the Meguma Group due to the lack of features recording this strain. Features that do record increments of flexural shear strain include offset discordant veins and en echelon veins. Horne and Culshaw (2001) determined flexural-slip shear strain recorded by discordant veins offset across movement horizons for two intervals at the Ovens Gold District, which record an “average shear strain” of  $0.48 \gamma$  (see Ovens stop, Day 1 below; Fig. 10). En echelon stratabound veins also provide a measure of flexural shear strain. The orientation of the pinned segment of the veins indicates the original orientation of the vein and the displacement in the profile plane the amount of shear strain (Fig. 5c). Shear strain recorded by en echelon veins determined at the Mooseland and Dufferin deposits are in the range of 2-3  $\gamma$ . However, this strain is restricted to individual slate intervals and when averaged for an entire section at Dufferin, en echelon veins record only  $0.28\gamma$  (Jodrey, 2002). The shear strain values for displaced veins and en echelon veins can only be considered minimum strain values during vein emplacement. Importantly, the recorded shear strain accounts for the last increments of folding and, because of the steep limb dips, the shear strain is accommodated by a small change in limb dip (see flexural slip strain in the Ovens Stop below, Fig. 10c). These observations illustrate how large shear strain localized in thin slate intervals can result from small changes in limb dip of already well developed folds, consistent with a general flexural-shear / saddle reef model of vein formation.

## DAY 1, Stop 1:

### OVENS ANTICLINE (GOLD DISTRICT)

The coastal exposure in the Ovens area offers a spectacular view of a MLGD vein array within an anticlinal hinge. This stop will focus on Rose Bay (Fig. 6b), where an oblique section through the hinge is exposed. The Ovens Anticline in the area occurs within in the lower Halifax Formation (Cunard member), consisting of interbedded slate and metasandstone. Numerous fold-related structures that will be pointed are highlighted in ***bold italics*** in the following text.

#### General Fold Structure:

The Ovens Anticline at this stop is a tight (interlimb angle of 35-40°) steeply inclined (~77°NW), gently plunging (6-25°NE) chevron fold (Fig. 6b). Metasandstone beds, in which tangential longitudinal strain has locally produced ***extensional veins*** in the outer arc (Fig 7, b; Ramsay, 1967), maintain thickness across the hinge, whereas slate beds are thicker in the hinge. ***Fine continuous cleavage*** within slate is axial planar on the limbs (Fig. 7a, 8). However, close to the outer arc of metasandstone hinges this cleavage has a ***divergent triangular pattern*** surrounding a neutral point (Fig. 7) resulting from inverse tangential longitudinal strain (Ramsay and Huber, 1987). ***Quartz-muscovite pressure shadows*** adjacent to arsenopyrite define a down-dip stretching lineation within the cleavage plane (Fig. 7). Both ***fold limbs are planar***, with no minor parasitic folds. Structural features in the hinge area are typical of chevron folds, with local accommodation structures including ***hinge thrusts***, ***bulbous hinges*** and ***saddle reefs*** (Figs. 7).

#### Flexural-slip structures

Evidence of flexural-slip folding is ubiquitous within the hinge are of the Ovens Anticline. The principal flexural-slip structures are bedding-parallel movement horizons and were ***identified by offset of quartz veins*** that are discordant to bedding (Figs. 7, 9a, 10). Movement horizons include thin, ***polished and striated slip planes*** with no marginal deformation and ***flexural-slip duplexes*** (Tanner, 1992). Quartz veins are common along movement horizons (Figs. 7, 9a), where they often have striated margins, and are interpreted to have been emplaced during flexural-slip ("***flexural-slip veins***").

***Movement lineations*** from the south limb in Rose Bay trend approximately perpendicular to the hinge whereas lineations from the north limb in Cunard Cove show considerable variation in trend, from perpendicular to highly oblique to the fold hinge (Fig. 6b) and two lineations were noted on some movement horizons, indicating variation in slip direction through time.

Shear sense determined from ***displaced conjugate veins*** (Fig. 9a, 10b), ***slickenfibres geometry*** and ***flexural-slip duplex geometry*** is invariably reverse, systematically changing across the fold hinge, consistent with flexural-slip folding.

Movement horizons are continuous at the same stratigraphic level for the ~10-20 metres of profile exposure and for up to 200 metres of strike-parallel exposure in Rose Bay. All movement horizons occur either within slate layers or at slate-metasandstone boundaries. Numerous bedding-parallel veins which are similar in character to flexural-slip veins occur along horizons where no slip is indicated by displaced discordant veins (Fig. 10a). However these veins may reflect flexural-slip

Fig. 6: (a) Simplified geology map of the Lunenburg area showing the location of the Ovens (after Faribault, 1929) For location within the Meguma terrane see Fig. 1. (b) Geological map and simplified cross section of the Ovens area showing the location of Rose Bay, where the hinge and south limb of the Ovens Anticline are exposed. Section E-E' is the location of cross section shown in Figure 8. Stereonets are for selected flexural-slip structural data for the Ovens Anticline.

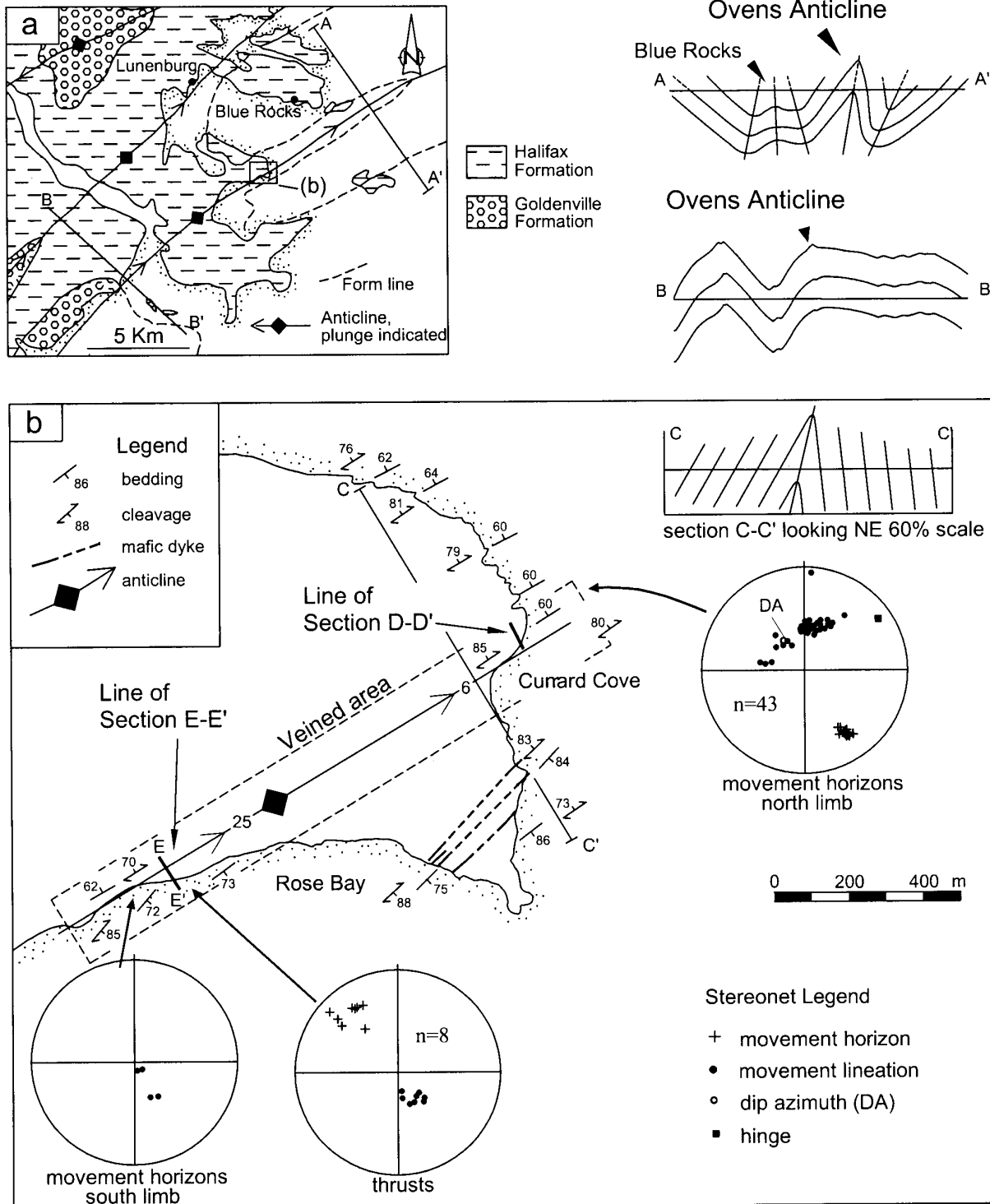

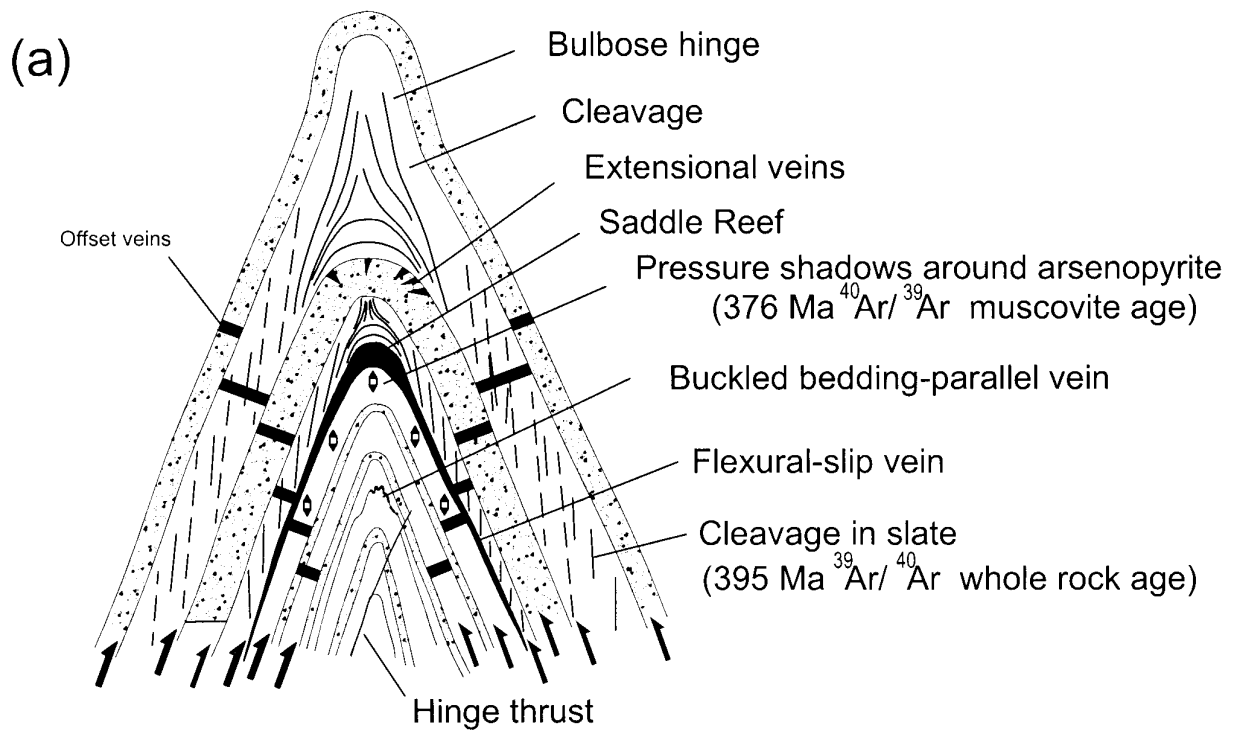
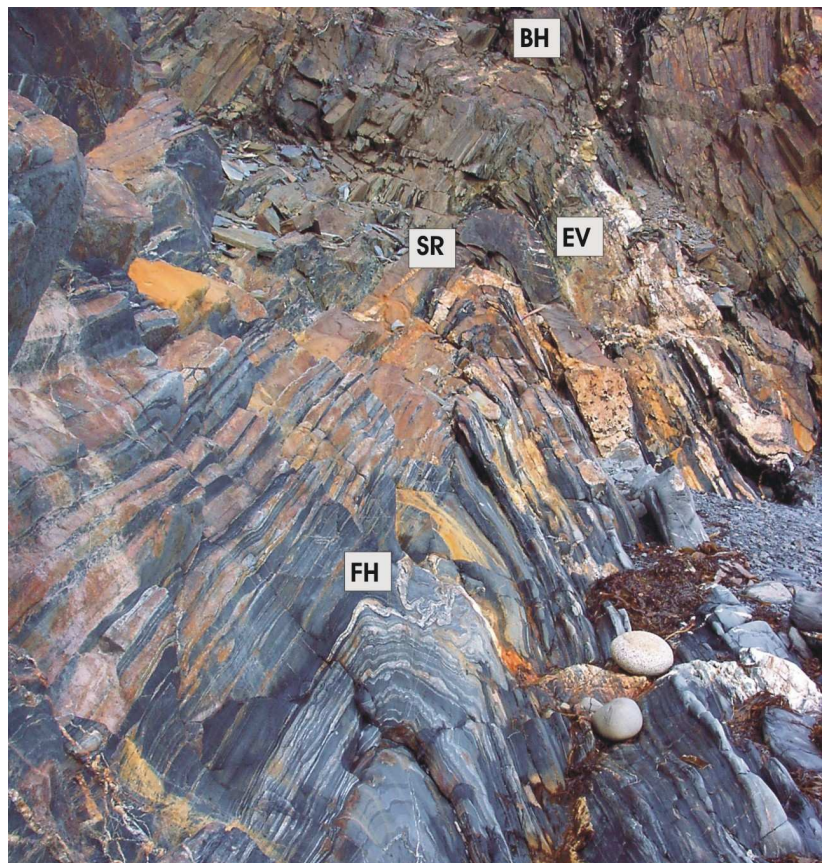

Figure 7: Sketch and photograph of the hinge of the Ovens Anticline exposed in Rose showing various structural elements of the fold referred to in text. In the photograph BH=bulbose hinge; SR=saddle reef; EV=extensional veins; FH= flat hinge. Note that layering and bedding-parallel veins are buckled in the flat hinge but planar on adjacent limbs.



movement horizons active prior to emplacement of discordant veins, which would reduce the average spacing of movement horizons.

### **Thrusts:**

Several *outcrop-scale thrusts* occur on the south limb of the anticline in Rose Bay (Fig. 8). Distinction of thrust sheets is apparent by *truncation of stratigraphy* and variation in the orientation of *structural elements (bedding-cleavage)* between sheets. Thrusts are characterized by striated fault planes and or laminated veins and show a reverse shear sense. Cleavage is at a high angle (locally near perpendicular) to bedding within the thrusts, implying they originated in a fold hinge.

### **Minor folds:**

Minor folds developed in bedding-parallel veins and or stratigraphic layering are found in two structural locations in Rose Bay; (1) folded bedding-parallel veins and layering, accompanied by mullions structures, occur *within the thrust sheets* on the south limb of the anticline (Fig. 8). (2) folded bedding-parallel veins and layering occur in the *hinge of the Ovens Anticline* in Rose Bay and Cunard Cove (Fig. 7). The folding is clearly restricted to the hinge region, whereas extensions of the folded veins and layers are *planar on the limbs* (Fig. 7). Restriction of minor folds to hinge areas of regional folds supports the view that minor folds developed in the “flat” hinge area late in the development of regional folds (compare Fig 3b with flat hinge in photo of Fig7).

### **Veins:**

Quartz veins are abundant in the hinge area of the Ovens Anticline, forming an *array of bedding-concordant and discordant veins* (Fig. 9a). The anomalous concentration of bedding-concordant and discordant veins is obvious and *mutual cross-cutting relationships* between both vein types (Figs. 9a,c) illustrates synchronous emplacement of the vein array.

**Bedding-parallel (*flexural-slip*) laminated veins:** There are abundant bedding-parallel veins on both limbs of the anticline. Individual veins vary but include the following features: (1) commonly have a laminated texture (locally speckled-hen texture, Henderson et al., 1990), (2) commonly occupy flexural-slip movement horizons defined by offset discordant veins (Figs. 7a, 9a, 9c), (3) commonly have striated margins and internal laminations (4) may be cut by or cut discordant veins (Figs. 9a, 9c) (5) may include fragments of cleaved slate, (6) commonly pinch and swell, (7) define down-limb extensions of saddle-reef veins (Fig. 7a) (8) commonly contain sulphide minerals (arsenopyrite, pyrite) and may contain gold.

**Buckled bedding-parallel veins:** Tightly buckled bedding-parallel veins locally occur, although, as discussed above, they are restricted to the fold hinge and down limb extensions are typical of bedding parallel flexural-slip veins (Figs. 7).

**Saddle reefs:** A classic saddle reef vein occurs in the hinge of the Ovens Anticline at the western end of the Rose Bay section (Figs. 7). Importantly, the down-dip extension of the saddle reef is represented by a laminated flexural-slip bedding-parallel vein, across which a discordant vein is displaced.



Figure 8: Cross section of the Ovens Anticline in the Rose Bay area. Location of section is shown in figure 6b. Zone A illustrates the structural character of the Ovens Anticline whereas Zone B shows the structural character of several thrust sheets emplaced on the south limb of the anticline.

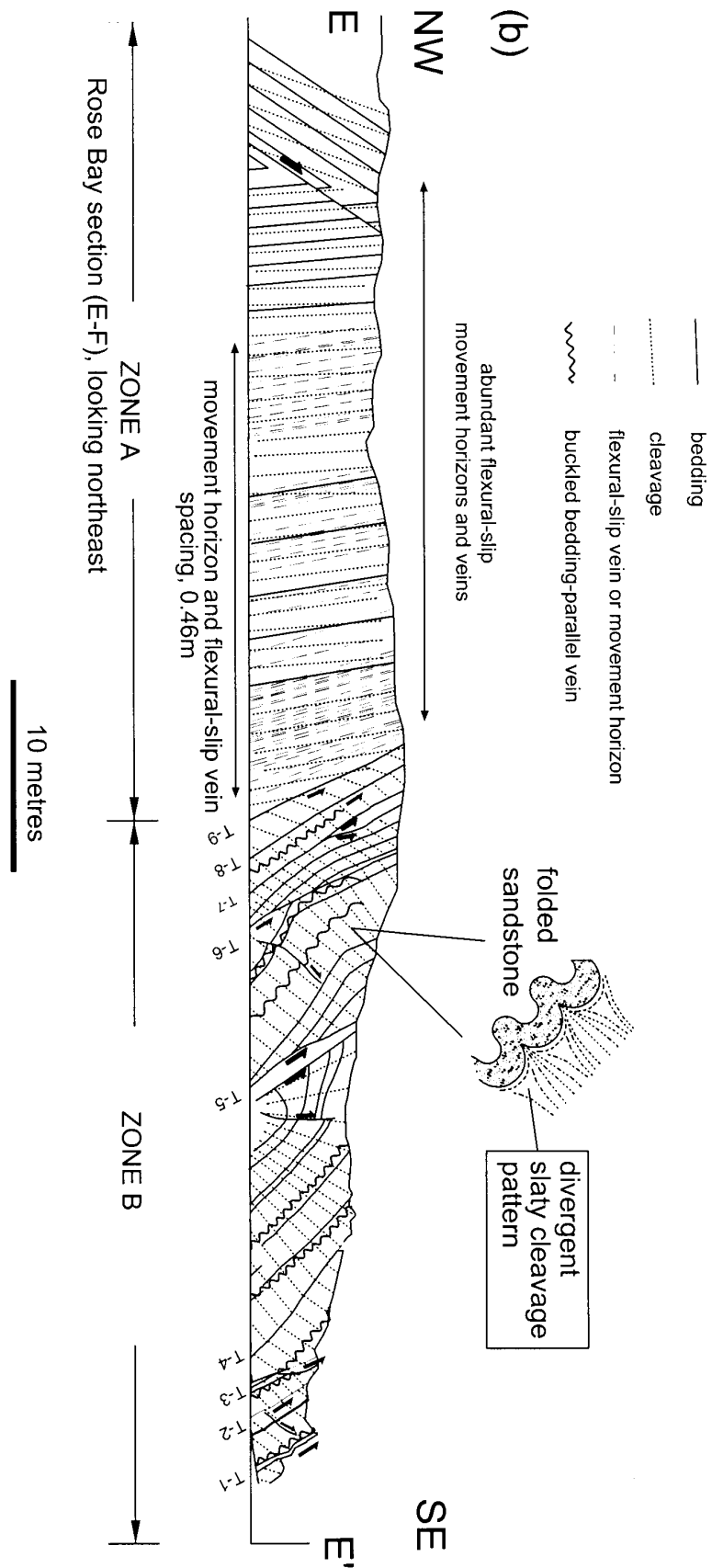
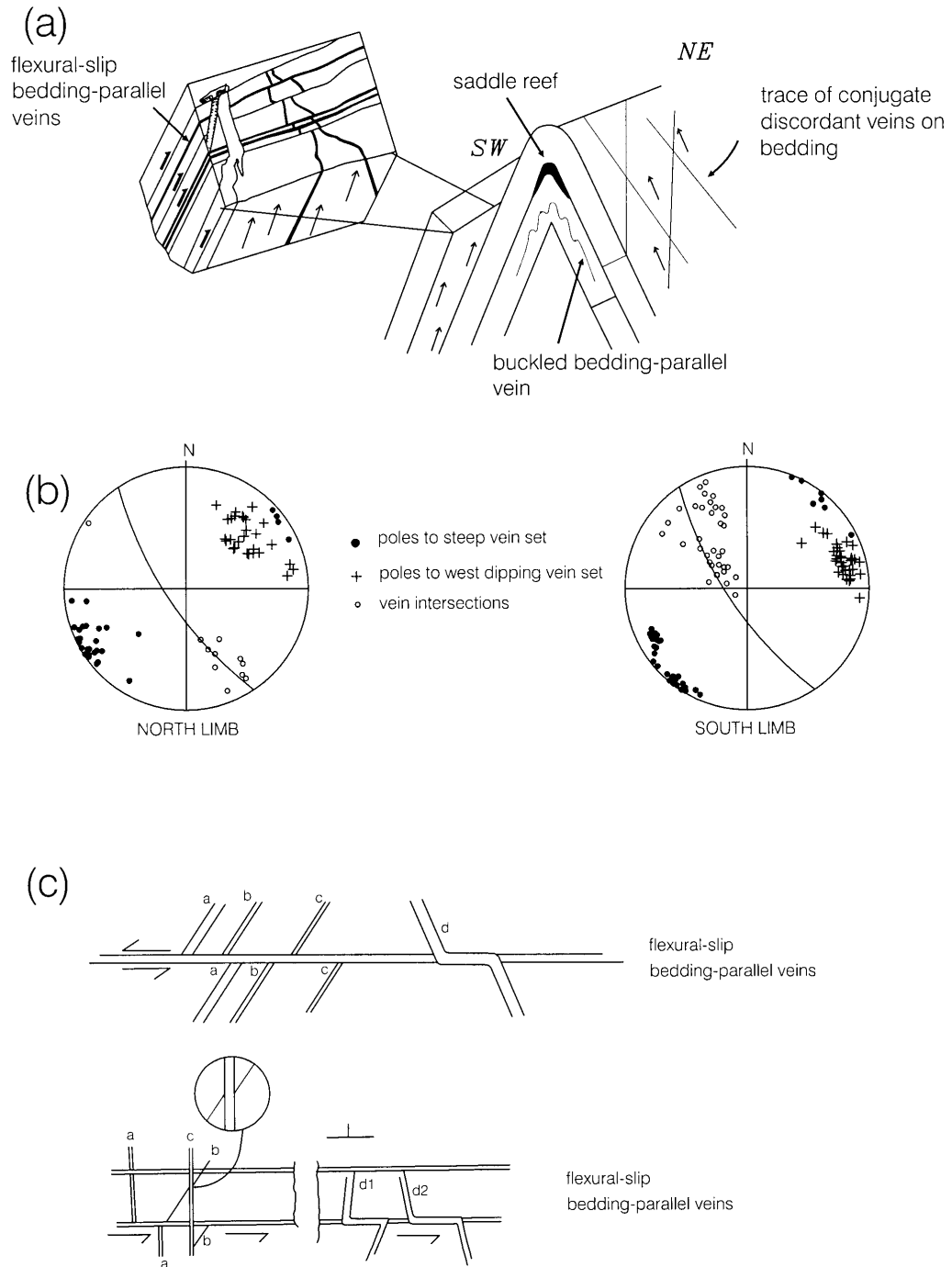

Figure 9: (a) Sketch of the Ovens Anticline, right, with inset figure showing the mutual cross-cutting relationship of flexural-slip bedding-parallel veins and conjugate cross veins. The cross veins to the right are offset along movement horizons occupied by (flexural-slip) veins whereas the cross vein to the left cuts the flexural-slip veins. (b) Stereonets of poles to a conjugate set (west- and steep-dipping) of cross veins and their intersection lineation, which fall along the ac plane of the fold. (c) Sketches showing mutual cross-cutting relationships between flexural-slip bedding-parallel and the conjugate set of cross veins.



**Discordant veins:** Abundant discordant veins occur which have mutual cross-cutting relationships with bedding-parallel veins, indicating synchronous emplacement (Figs. 9a, 9c). Discordant veins consist of a systematic conjugate set with steep and west-dipping veins. The obtuse bisector of the conjugate vein sets is parallel to the fold hinge and their intersection lies dispersed within the ac plane of the fold (Fig. 9b).

**GOLD** can be found in all vein types, with the most abundant visible gold occurring in a discordant vein which cuts a thrust sheet. This is consistent with the mutual cross-cutting relationships of bedding-parallel and discordant veins.

### **Timing of vein emplacement:**

The vein array occurs within flexural-slip structures that deform fold-related cleavage and locally host cleaved slate fragments, indicating a post cleavage (metamorphic) age. Saddle reefs are an essential part of the vein array and implicitly develop late in fold development. Mutual cross-cutting relation between bedding-parallel and discordant veins, which show only minimal deformation, support late vein development.

Limited isotopic dating includes: Whole rock  $^{40}\text{Ar}/^{39}\text{Ar}$  dating of slate gave an age of ca 399 Ma Kontak et al. (1999), interpreted to reflect cooling through the retention temperature for argon in micas ( $300^{\circ}$ - $350^{\circ}$  C). Muscovite separates from pressure shadows gave an age of  $376\pm 2$  Ma (Hicks et al. 1999), which has been interpreted as the age of flexural-slip deformation and vein development. However, a Re/O age for arsenopyrite from a bedding-parallel vein gave an age of ca. 409 Ma. This Acadian age for the arsenopyrite is incompatible with the inferred post-metamorphic age for vein development???

### **Flexural-slip strain:**

The amount of flexural slip recorded by offset veins for two intervals in Cunard Cove is shown in Figure 10a. The cumulative slip and related shear strain for each interval is given as the cumulative total slip parallel to variably trending displacement vectors ( $X_T$ ,  $\gamma_S^T$ ) and the cumulative slip projected into the fold profile plane ( $X_P$ ,  $\gamma_S^P$ ). The amount of limb dip change due to a given increment of flexural-slip shear strain depends critically on the limb dip at which that increment is applied. In the Ovens Anticline, flexural slip represents a very late increment of folding and the change in limb dip ( $\xi$ ) resulting from the measured flexural-slip shear strain (0.48; i.e.,  $\gamma_S$  for corrected slip) is small ( $3.77^{\circ}$ ) (Fig. 10c). Note that inclusion of all bedding-parallel veins similar in character to those along movement horizons as slip surfaces would clearly increase the contribution of flexural slip to folding and thus increase the change in limb dip due to flexural slip.

### **Summary:**

Excellent exposure has allowed for detailed observations of the character of the hinge area of the Ovens Anticline and associated auriferous vein array. The Ovens Anticline is a classic chevron fold displaying all the typical (text book) structures of such folds. Anomalous concentrations of bedding-parallel and discordant veins form a vein

Figure 10: (a) Structural-stratigraphic log from the Cunard Cove area which shows the location of flexural-slip movement horizons and “flexural-slip veins”. The amount of displacement on movement horizons determined by the offset of discordant veins is shown graphically for two intervals of the section, with the amount of resulting flexural shear strain given (see text for explanation). (b) Sketch showing the method of determining the displacement on movement horizons recorded by offset cross veins. (c) Diagram showing the method of determining the change in limb dip resulting from the flexural-slip shear strain recorded, assuming this strain was the last increment applied.

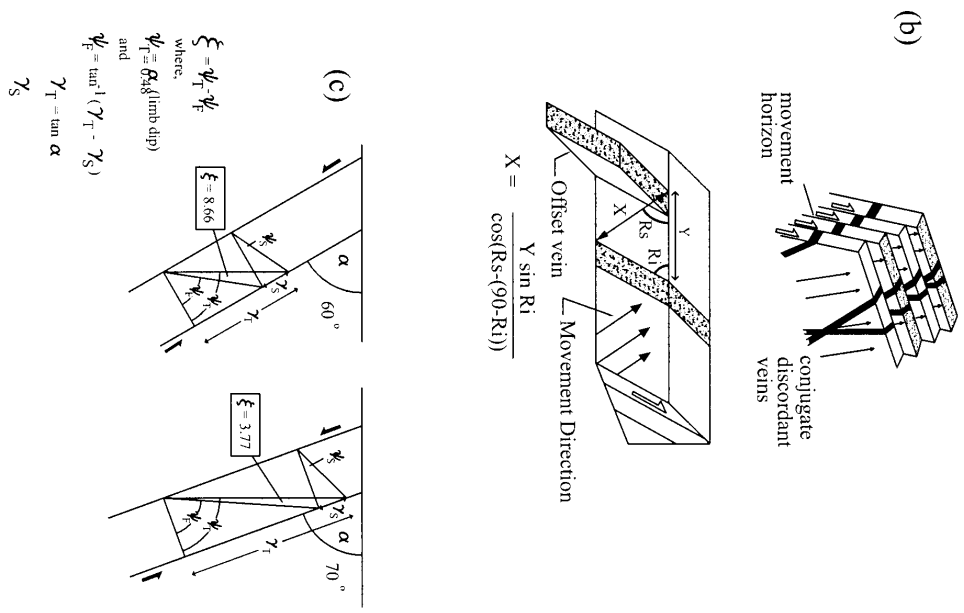
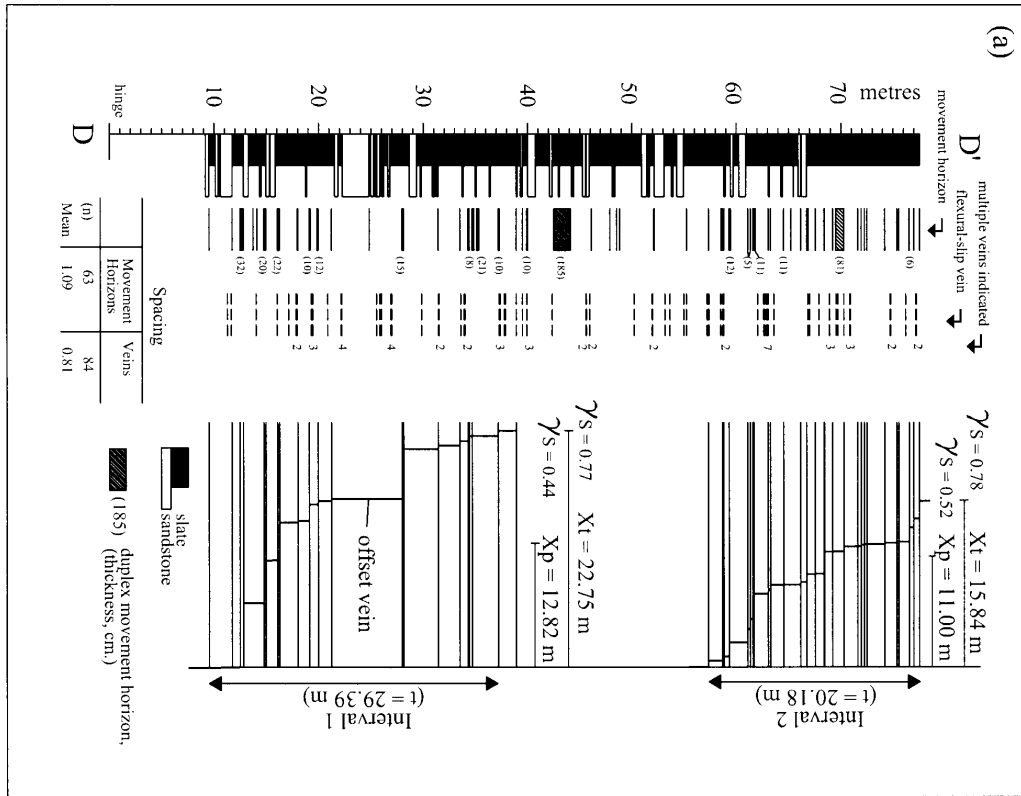

array which was emplaced along structures representing flexural-slip and synchronous hinge-parallel extension (discordant veins) late in the chevron fold development.

With respect to the general consideration of the hypothesis that MLGD largely represent bedding-parallel veins which experienced layer-parallel prior to folding, I would note that the buckled veins at the Ovens have be used as examples in support of this theory (Henderson et. al, 1992; Graves and Zentilli, 1982). Are these few buckled veins representative of MLGD? The thrust sheets offer the best evidence of layer-parallel shortening (mullions, shortened sedimentary structures, buckled bedding-parallel veins), however bedding-parallel veins within the thrusts are limited to only a few thin veins, in stark contrast to the overwhelming number of flexural-slip bedding-parallel veins which characterize the Ovens Gold District.

### **LUNCH: HISTORIC LUNENBURG:**

The town of Lunenburg offers a glimpse of historic Nova Scotia and a great place to have lunch. Lunenburg was established in 1753 and much of the “old town” is unchanged from its early development during the 19<sup>th</sup> century. In 1995 the town was designated a UNESCO (United Nations Educational Scientific and Cultural Organization) world heritage site. Of course, Lunenburg is the home of the famous Bluenose schooner (check your dimes) which proudly dominated the International Fishermens’s Race in the 1920's (against the Americans!).

## DAY 1, Stop 2:

### UNIACKE AREA:

We will make two quick stops in the Uniacke area, north of Halifax to look at minor folds development in coticule layers (spessartine rich rock) which give further insight into the history of regional fold development and layer-parallel shortening.

#### ***Highway #1 pit “L2”:***

An abandoned gravel pit exposed on the north limb of the Uniacke Syncline located on Highway #1 (Fig. 11) includes a coticule-bearing interval at the north end of the pit. A profile section of the coticule is exposed close to the highway, which shows the character of minor folds (Fig. 12). Shortening values recorded by minor folds range from 8-41% with an average of 22% (Young, 2000).

#### ***South Uniacke pit “L1”:***

Coticule layers are exposed in an abandoned gravel pit occurring on the steep south limb of the Uniacke Syncline in South Uniacke (Fig. 11). The coticules layers in this location are planar, showing no evidence of buckling (Fig. 13).

The variance in minor fold development between the highway and South Uniacke pits is striking. Young (2000) interpreted this variance to reflect the character of regional box-chevron fold development, where the amount of shortening is dependant on the time spent in a fold hinge; either the flat segment of a box fold or hinge of a chevron (Fig. 14). The unbuckled coticules at the South Uniacke pit are interpreted to represent a limb formed at the onset of regional fold development (location L1, Fig.14) whereas the moderate bucking of coticule layers at the Highway #1 pit reflects migration of a hinge onto a limb during fold development (Location L2, Fig. 14). This conclusion has significant implications for interpreting MLGD as it precludes *homogenous* layer-parallel shortening of bedding-parallel veins prior to regional folding as proposed by Henderson et al. (1986) and Graves and Zentilli (1982).

Figure 11: Simplified geology map of the Uniacke area showing the locations the highway #1 pit (L2) and South Uniacke pit (L1) stops. For location in the Meguma terrane see Fig. 1.

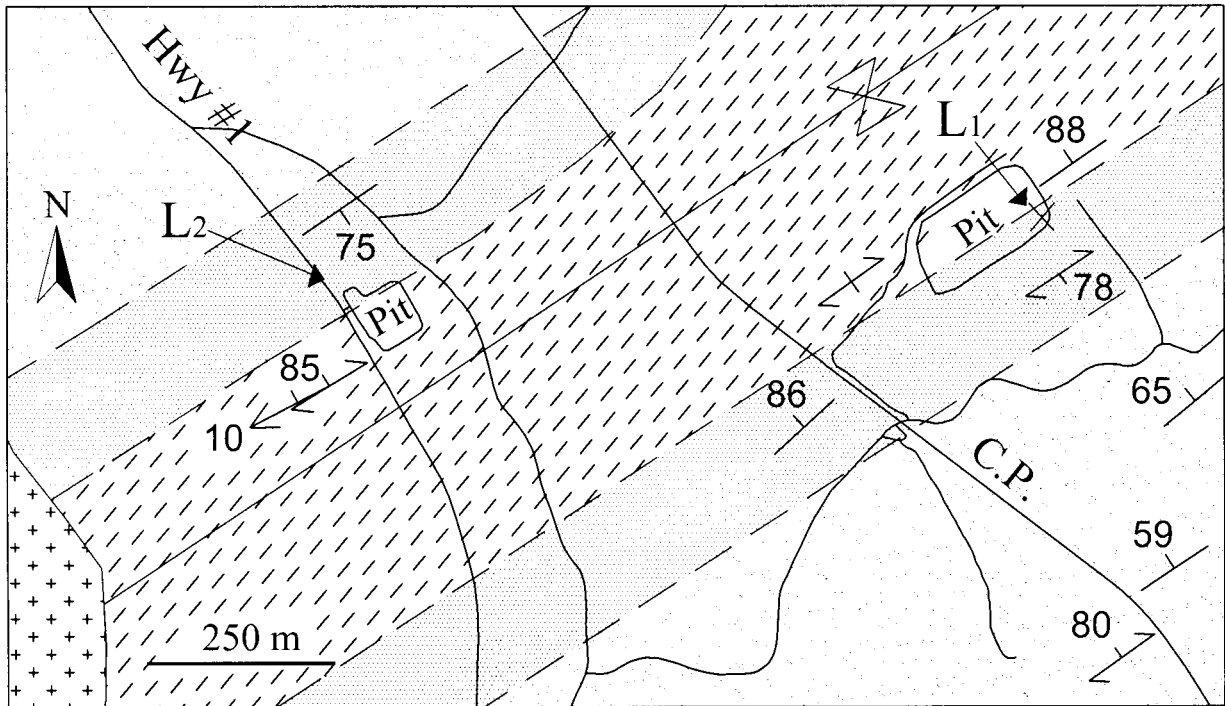

South Mountain Batholith (Devonian)

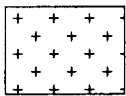

South Mountain Batholith

Meguma Group (Cambro-Ordovician)

*Halifax Formation*

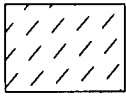

Cunard member



Beaverbank member

*Goldenville Formation*

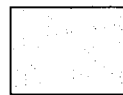

undivided

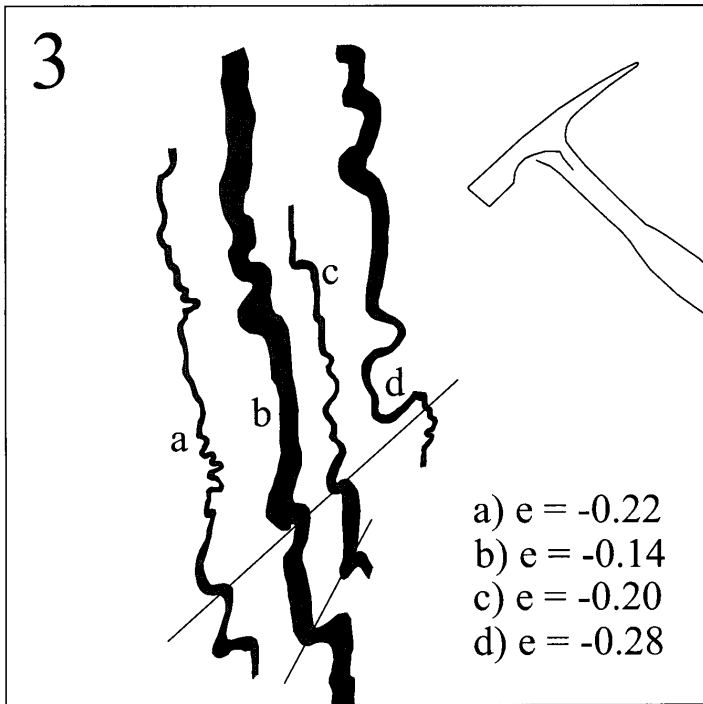

Figure 12: Sketches of buckled coticle layers at the Highway#1 pit. Shortening values,  $e$ , are given for individual coticle layers.

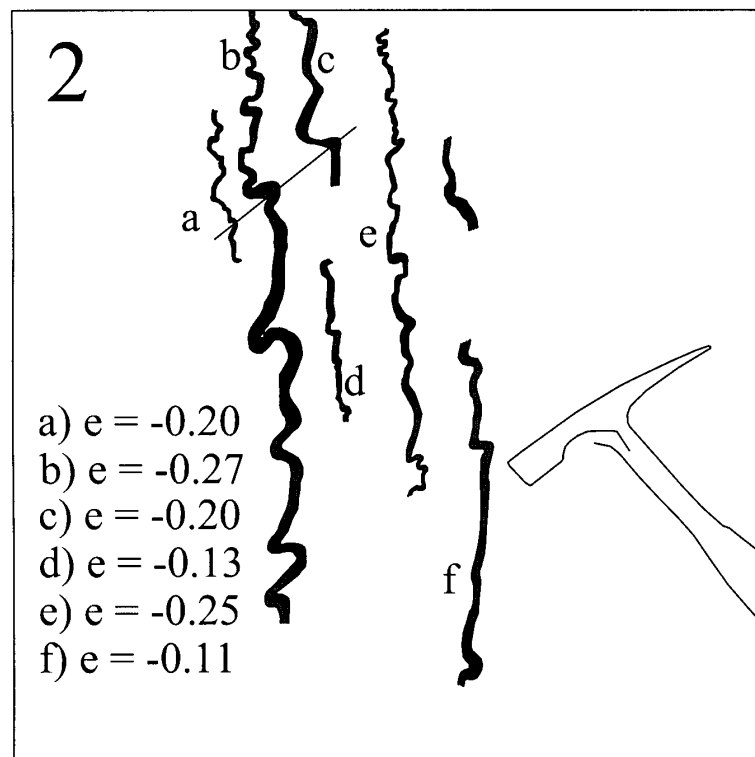
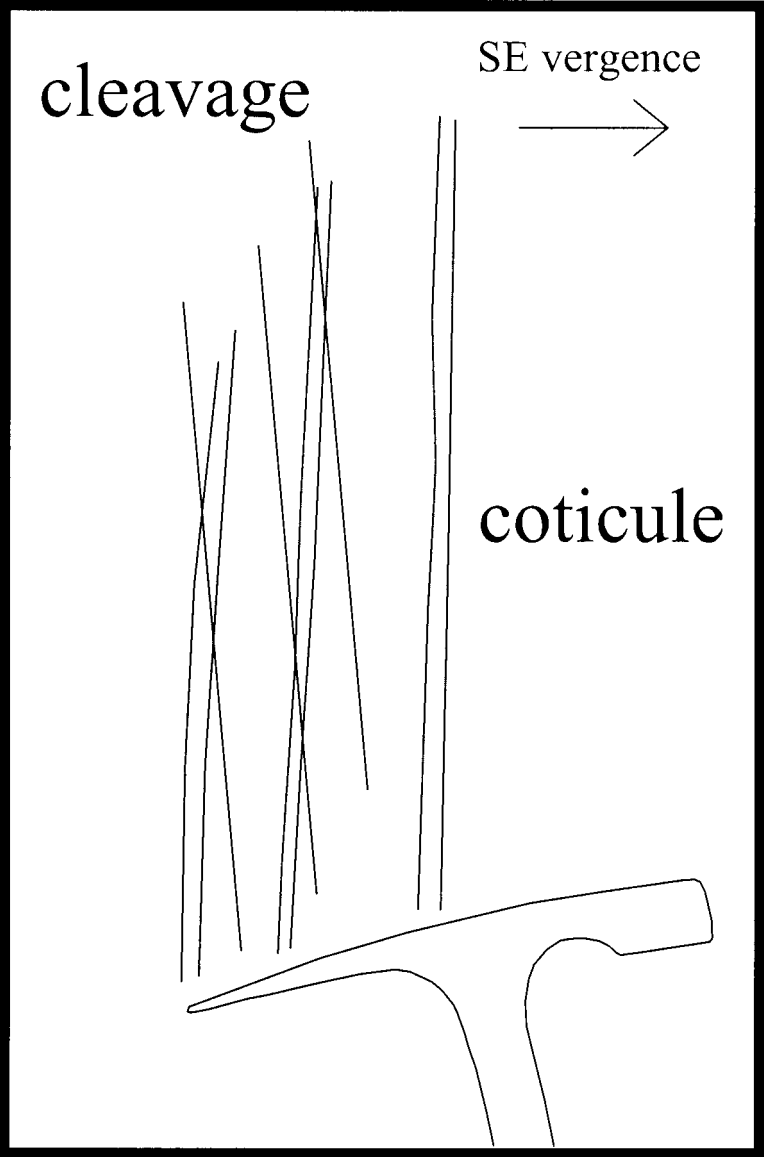
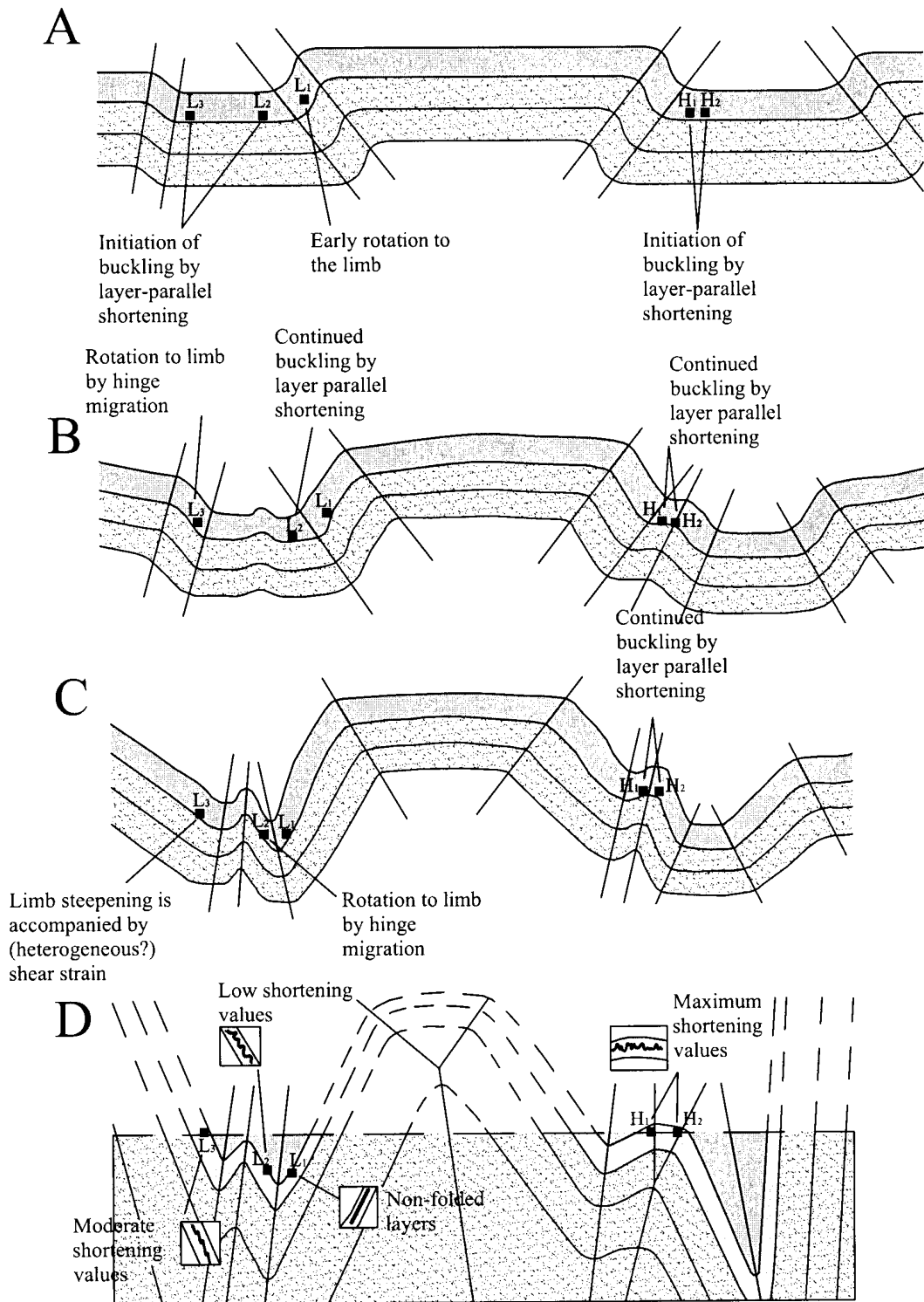



Figure 13: Sketch showing the character and relationship to cleavage of coticule layers in the South Uniacke pit





Possible sequence of fold development in the profile plane for the central Meguma. Stage D represents the present-day cross-section. (after Young 2000)

Figure 14:

## DAY 2

Today we will focus on two mines along the Eastern Shore of Nova Scotia that are operated by Azure Resources Limited of Vancouver. Development of the Mooseland deposit is occurring below the area of historical work whereas the development of the Dufferin deposit is on a faulted extension of the historical working. Underground development of these deposits provides excellent exposures of MLGD vein arrays. This should be an enjoyable and insightful day.

### DAY 2: Stop 1

#### *AZURE MOOSELAND MINE*

##### **Introduction:**

At the time of writing this guidebook it was doubtful that the underground at the Mooseland Mine would be accessible. We will visit surface exposures at the mine site and, if possible, the underground as well.

The Mooseland gold district was discovered in 1858 and gold was mined intermittently between 1863 and 1934, with total production recorded at ca 3,865oz (Bates, 1987). Historical work focused on stratabound veins on the south limb of the Mooseland Anticline hosted within slate or metasiltstone intervals of the metasandstone-dominated Goldenville Formation. Where two or more distinct veins occur within a slate interval the term “belt” is used to refer to the stratigraphic interval hosting those veins. A decline was initiated on the north limb of the Mooseland Anticline that cuts perpendicular through the south limb, exposing the Bismark, Irving, Little North and Cummings belts (inset, Fig. 15b).

##### **General Structure:**

The Mooseland Anticline defines a steep, tight (inter-limb angle of  $\sim 35^\circ$ ) chevron structure (Fig. 16b). A well-developed fine continuous cleavage in the slate-metasiltstone is steeply dipping, with a small angle to bedding, whereas a well developed spaced, pressure solution cleavage in the metasandstone is generally observed at a moderate angle to bedding (Fig. 16a). Bedding-cleavage intersection lineations and fold hinges invariably plunge slightly to the east. There is a notable thickening in the hinge zone, typical of chevron style folds, which is accommodated by flow of metasiltstone and slate and saddle reef formation (Fig. 16b).

Distinct elongate mineral aggregates, oikocrysts (Kontak et. al., 1990), which define a pronounced mineral lineation are ubiquitous within dark slate-metasiltstone intervals throughout the Mooseland district and have been previously described by Melvin (1987) and Kontak et. al. (1990). These mineral aggregates are typically pencil-shaped, with a long axis measuring 1-2 cm and a width of 1-2mm. The aggregates occur within the cleavage plane, their long axis is perpendicular to the fold axis (Fig. 16a), and they are interpreted to record fold-related strain. Quartz pressure shadows occurring on sulphide minerals, most notably arsenopyrite, also define a down-dip lineation, likely recording the same fold-related strain as the oikocrysts.

Figure 15: (a) Simplified geology map of the Ship Harbour-Sheet Harbour area of eastern Nova Scotia showing the location the Mooseland Gold District. (b) Geology of the Mooseland Gold District showing the location of the recent underground working of Azure Resources and the stripped hinge area shown in Figure 17. Inset figure is a plan view of the underground working showing the main “belts” and the location of section line for the cross section shown in Figure 16.

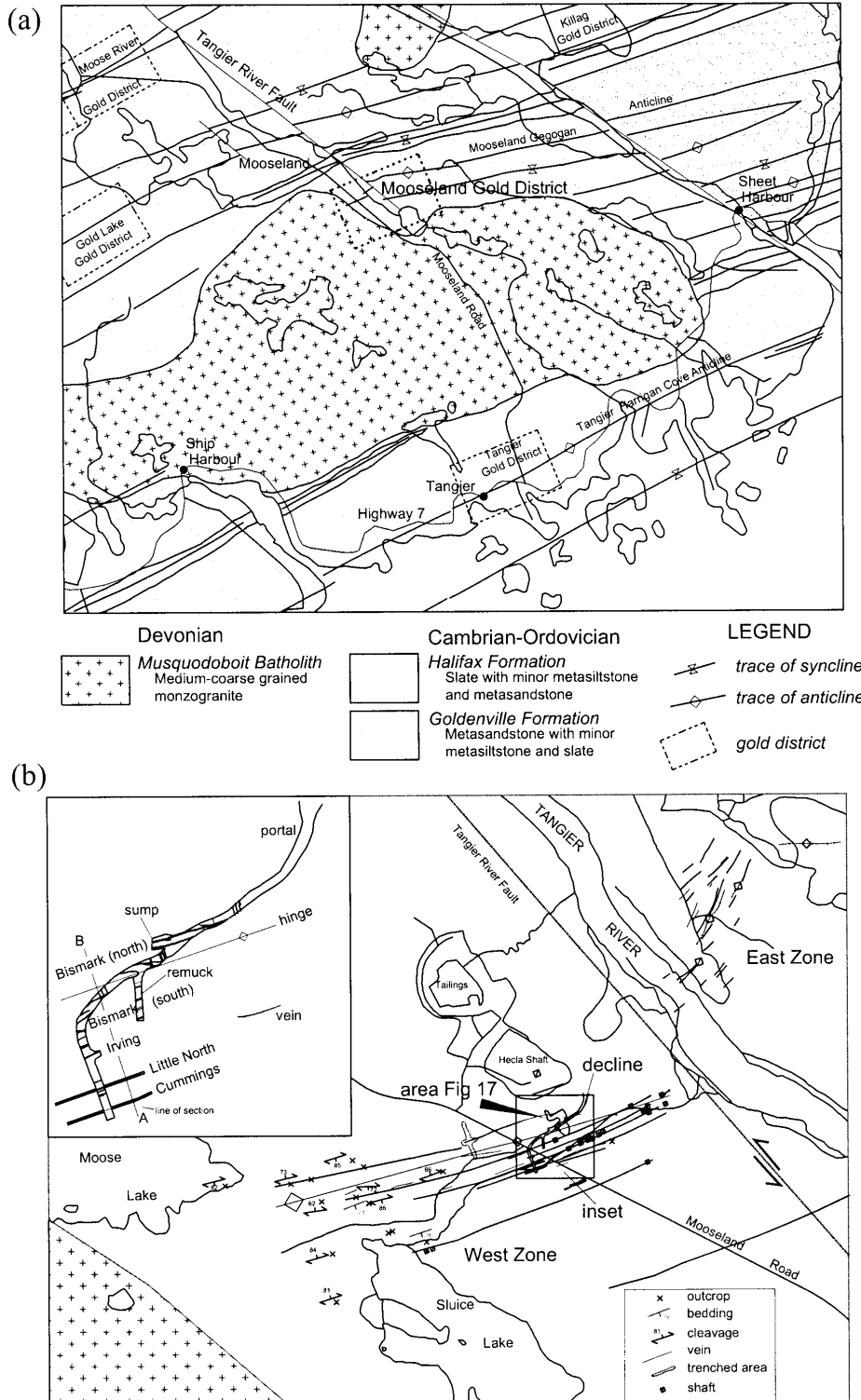
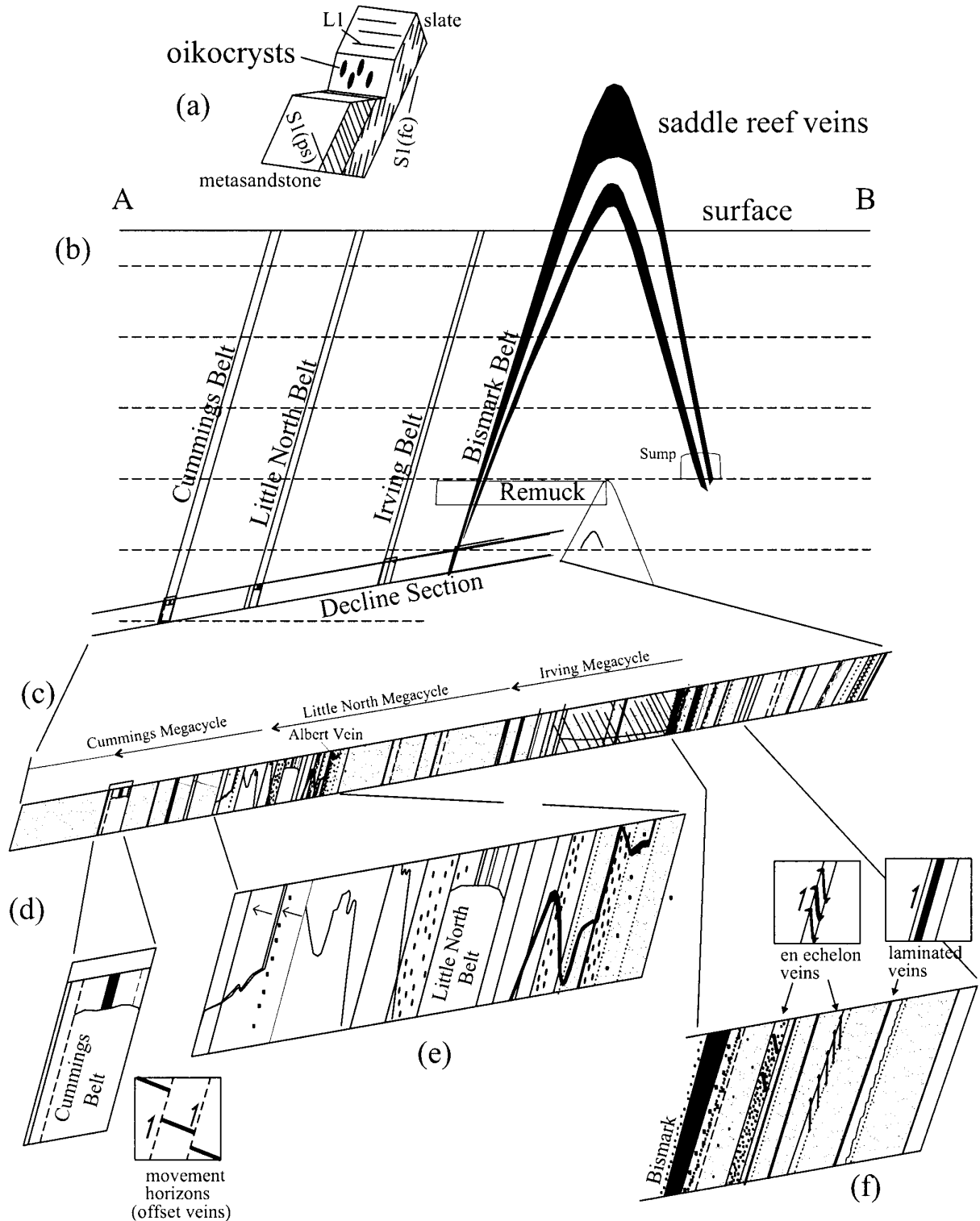

Figure 16: (a) Sketch showing the relation of various structural elements in the Mooseland Anticline. (b) Cross section showing the general chevron character of the Mooseland Anticline and the distribution of the principal belts. (c-f) Maps showing the distribution of veins on the west wall of the decline.



**Stratigraphy:**

Stratigraphy is typically comprised of cycles dominated by metasandstone fining upward into relatively thin metasilstone and or slate intervals. Contacts within cycles are gradational, however contacts between cycles are usually sharp. There is at least an apparent large-scale systematic stratigraphic variation, characterized by thick intervals of metasandstone-dominated cycles with only very minor metasilstone-slate and thinner intervals dominated by relatively thin cycles where slate-metasilstone represent larger parts of individual cycles. This systematic variation may represent large-scale sedimentary cycles (megacycles) that, like individual cycles, are characterized by thick metasandstone-dominated intervals overlain by thinner intervals with significant metasilstone-slate (Fig. 16c). Although minor bedding-concordant veins occur within thin metasilstone at the tops of individual thick metasandstone-dominated cycles, the main bedding-concordant veins occur within the intervals of relatively thin cycles at the top of megacycles and represent the veined and mineralized “belts”.

**SURFACE EXPOSURE*****Hinge area:***

The hinge area of the Mooseland Anticline has been exposed just south of the mine site (Fig. 15b, 17). Two thick bedding-concordant veins exposed on either side of the hinge represent the Bismark Belt. The structurally higher vein occurs at the contact with a thick overlying interval of metasandstone (we will see this section underground as well). These veins taper down dip, with one vein pinching out completely, and define a saddle-reef geometry (Fig. 16b). The veins are mainly massive, coarsely laminated quartz. The veins converge to the east, in the direction of plunge. Elongate mineral aggregates (oikocrysts) define a pronounced down-dip mineral lineation perpendicular to the fold, clearly recording fold-related strain. Oikocrysts consist of biotite, chlorite, quartz, carbonate and quartz and commonly are zoned, with biotite rims. Oikocrysts are presumed to have a metamorphic or metasomatic origin. The Mooseland deposit is proximal the Musquodoboit Batholith, suggesting oikocrysts may reflect contact metamorphism. However, oikocrysts are common in many MLGD and their restriction to vein arrays, regardless of proximity to intrusions, supports a metasomatic origin related to vein emplacement. Locally, quartz pressure shadows on arsenopyrite also define a down-dip lineation. There are numerous cross veins exposed which show varying amounts of shortening (folding), which varies depending on the lithology.

**UNDERGROUND**

The underground development cuts across the Bismark, Irving, Little North and Cummings Belts.

**Remuck Section:**

The first remuck station provides a cross section that exposes the Bismark Belt and structurally lower veins (see Fig. 16f).

Figure 17: Map of exposed outcrop in the hinge of the Mooseland Anticline (see Fig. 15b for location). Quartz veins straddling the hinge represent the Bismark Belt.

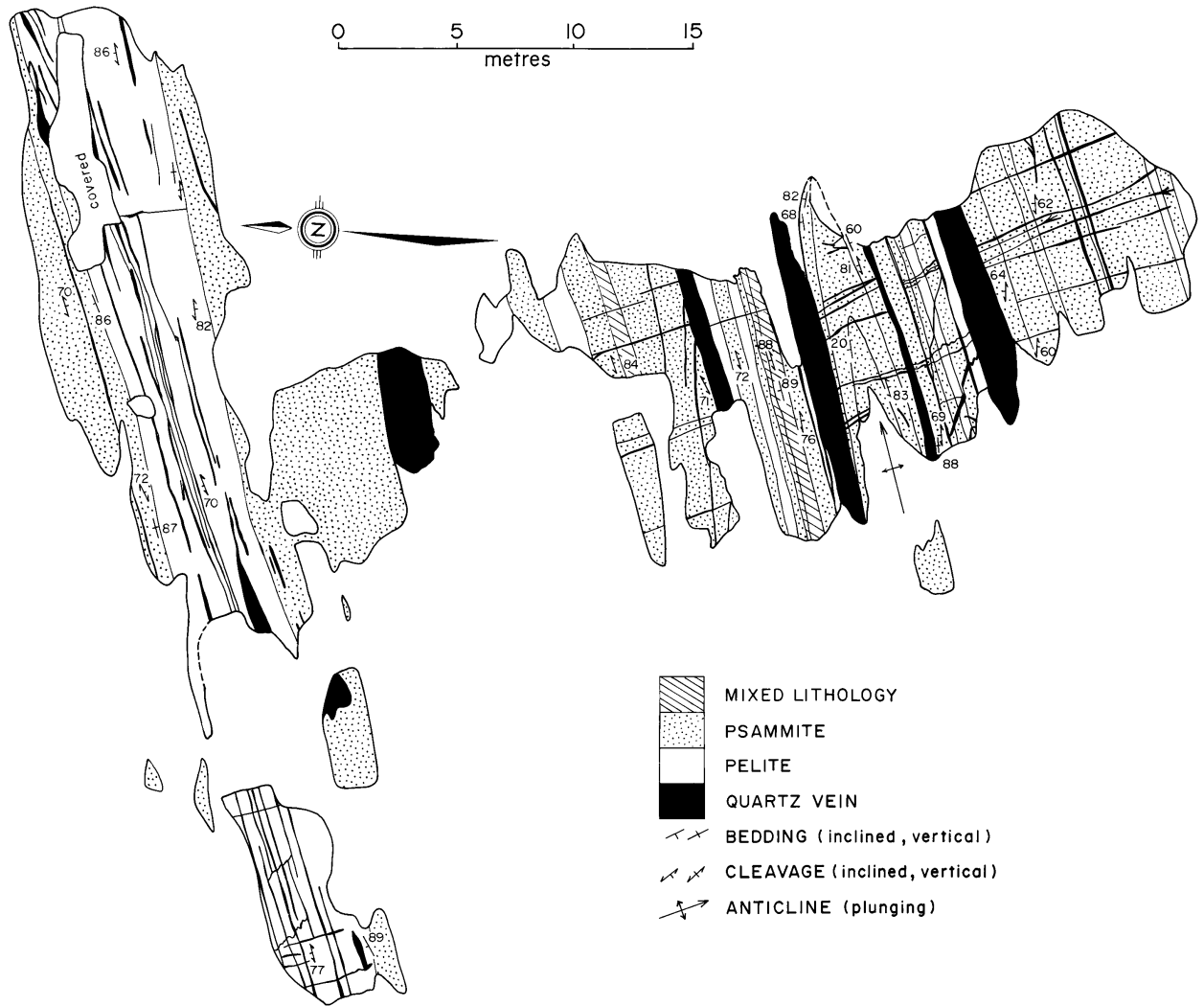

### ***Bismark vein:***

The south legs of the Bismark vein (exposed on surface) are exposed here. These veins thin down-dip, defining a saddle reef geometry. This vein is hosted by black slate and is characterized by coarse laminations and abundant coarse arsenopyrite within the vein and adjacent wall rock.

### ***Movement Horizons:***

Several movement horizons, characterized by thin clay seams occur at lithologic contacts and within slate intervals.

### ***En Echelon veins:***

Two sets of bedding-concordant en echelon vein arrays occur immediately below the Bismark vein (Fig. 16f). Individual veins have a ***sigmoidal shape***, cross-cut metasiltstone intervals, with their ends are ***pinned*** in metasandstone. The intersection of these veins with bedding is parallel to the fold hinge and they record a ***shear sense*** consistent with flexural shear; movement of the structurally higher beds toward the hinge.

### ***Laminated bedding-parallel veins:***

A laminated bedding-parallel vein occurs below the en echelon veins (Fig 16f). This vein is ~3cm thick and is characterized by a distinct ribbon texture. This vein is exposed on the steep limb, where it is ***planar***, and persistent along strike in diamond drill holes, consistently yielding elevated gold values.

### ***Buckled bedding-parallel vein:***

A thin (1-2cm), tightly folded (locally isoclinal) bedding-parallel vein is exposed on the south limb in the remuck station and in the fold hinge in the decline adjacent the remuck station. Fold geometry is parasitic to the main anticline and fold tightness decreases down dip. The lack of buckled veins on steep fold limbs away from the hinge zone, both in the underground development and diamond drilling, suggests that buckling is restricted to the hinge area.

## **Little North Belt:**

The Little North Belt includes three distinct bedding-parallel veins and several “angular” veins. Each of the bedding-parallel veins (Footwall, Twin, Covey; Fig. 18) are distinct, consisting of massive to laminated quartz, are planar (unfolded), and laterally continuous. The angular veins consist of discordant veins (massive quartz) oriented at a small angle to bedding. Where angulars intersect bedding-parallel veins they commonly follow them for a distance before exiting. The result is local thickening of the bedding-parallel vein that has a composite laminated and massive texture. The discordant segments of angular veins are strongly folded (Fig 18a). The hinges of the folded angular veins and their intersection with bedding plunge moderately to steeply east and the enveloping surface of folds migrate down dip as it goes up section; the enveloping surface of the folds is shallower than bedding (Fig. 18a).

Although only limited structural data exists for the angular veins, they show no apparent relationship to the shallow plunging Mooseland Anticline, and the mechanism of



Figure 18: (a) Diagram of the decline and drift on the Little North Belt showing the arrangement of bedding-parallel and angular quartz veins. Discordant segments of the angular veins are folded, with fold hinges plunging to the east (right). (b) Schematic diagram of angular veins projected on a profile section of the folded segments illustrating formation and subsequent folding as a response to bedding-parallel shear. (c) Diagrams contrasting the orientation of bedding-parallel shear recorded by the flexural-shear vein array to that recorded by the angular veins.

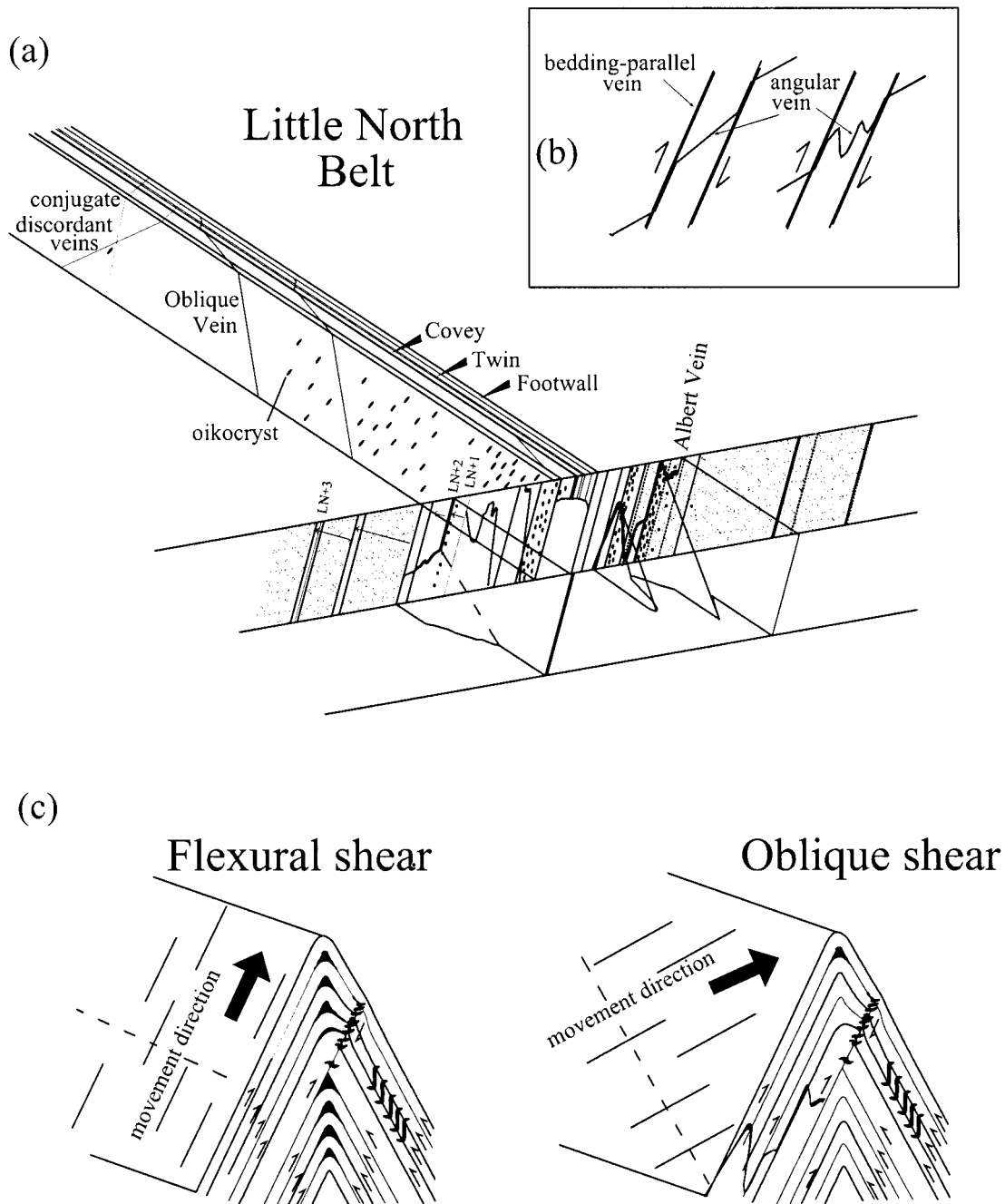

vein development is not obvious. Viewed in a profile section of the folds defined by the angular veins, these veins show a similarity to “angular veins” (Faribault, 1899b; Armstrong, 1937) and can be explained by progressive bedding-parallel shear perpendicular to the fold hinges of the folded angular veins (Fig. 18b). The angular veins formed as linked bedding-parallel and discordant segments, the latter representing extensional veins, in response to oblique, sinistral, reverse bedding-parallel shear, with discordant segments becoming folded. The kinematics of the angular veins is not consistent with flexural-folding strain (Fig. 18c), which is recorded by bedding-concordant veins and oikocrysts, and the mechanism of vein formation is not understood. Although the shear strain implied by the folds is significant, as of yet we have not recognized features recording this strain within the wall rock.

As observed in other MLGD (see angulars in the introduction) angular veins appear to be important for mineralization within the Little North Belt. Anomalous sites of coarse gold, accompanied by base metal sulphide minerals (galena, chalcopyrite, sphalerite), occur in the bedding-parallel segments of the angular veins, commonly occurring at the margin of the massive quartz of the angular and the laminated bedding-parallel vein. Without explanation, visible gold and base metal sulphide minerals were not observed within the discordant segments of the angular veins. The restricted mineralized portions of the bedding-parallel veins define ore shoots which plunge steeply east (parallel to the hinges of the folded angular veins), recognition of which are critical for economic mining.

### **Cummings Belt:**

The Cummings Belt is characterized by a thick (~30cm), coarsely laminated vein that resembles the Bismark Vein. If this vein represents a leg reef, the saddle, which has been eroded away, was presumably of considerable thickness. A prominent movement horizon in the footwall of the belt, consisting of 1-2 cm of fault gouge, offsets discordant veins. A quartz veins locally occurs within the movement horizon. A 3 cm thick bedding-parallel quartz vein also occurs in the hanging wall of the belt.

### **MOOSELAND SUMMARY:**

The Mooseland Vein Array is typical of MLGD, with examples of all the main vein types present (compare with introduction). The spatial association of and relationship between various veins strongly supports a common origin for most veins and vein characteristics are consistent with a flexural-shear model. Angular veins cut the flexural-shear bedding-parallel veins, recording a later bedding-parallel shear that is oblique to that of flexural shear. The angular veins appear to be important for the introduction of gold.

## **DAY 2: Stop 2**

### ***AZURE DUFFERIN MINE***

#### **Introduction:**

The Azure Dufferin Mine represents the faulted extension of ‘Dufferin Mines’ (Fig. 19a), where significant previous mining has occurred (reported gold production is 41,801 oz.; Bates, 1987). Displacement along the Harrigan Cove fault records ~1200 metres of sinistral strike-slip separation (Fig. 19a). Several minor faults within the Azure mine that are parallel to the Harrigan Cove Fault show oblique, sinistral, east-side-down displacement (Fig. 20). If similar displacement occurred on the Harrigan Cove Fault, then the Azure deposit could represent a much higher structural level than the “Dufferin Mines”.

Limited diamond drilling has established 13 zones of saddle reefs, some including 2 or 3 individual reefs (Fig. 19b). The upper 2 reefs have been defined for approximately 700 metres of strike length. Mining to date has been primarily focused on Saddle 1 and 2, although development has reached Saddle 4.

The Azure Dufferin mine represents a series of saddle-reef veins within the hinge of the Crown Reserve Anticline, which defines a tight (interlimb angle of ~47°) chevron-style fold which is steeply inclined to the south (Figs. 19b). The hinge zone of the fold typically defines a rounded arc-shaped structure approximately 5-10 metres across and the limbs are uniform and straight. Variations noted in the hinge zone include local flat segments and minor M-folds, where the flat segment has been folded into an open syncline. A well-developed axial planar cleavage consists of a spaced (pressure solution) cleavage in metasandstone and a fine continuous cleavage in metasilstone and slate. There is strong cleavage refraction, from a convergent pattern in metasandstone, with bedding-cleavage angles of ~50°, to a divergent pattern in metasilstone and slate, where cleavage is commonly subparallel to bedding.

Stratigraphy within the deposit is comprised predominantly of medium- to thickly-bedded metasandstone with lesser metasilstone and slate. A typical sedimentary sequence defines a fining upward cycle of thick, massive metasandstone, gradationally overlain by laminated metasilstone and slate. An average cycle includes approximately 1 metre of metasandstone, 5-10 cm of metasilstone and a couple centimetres of slate. However, some cycles are almost exclusively metasandstone, with < 1 centimetre of slate, whereas other cycles include over a metre of metasilstone and slate.

#### **UNDERGROUND STOPS**

The locations of the underground stops are shown on Fig 20.

#### **Portal:**

The portal is established in the uppermost Saddle (1a) and provides a good point to introduce the vein system. Saddle 1a is exposed at the top of the portal and consists of a 1m+ thick saddle, which is notably asymmetric with respect to the fold. The north side of the saddle

Figure 19: (a) Location map of the Azure Resources Dufferin Mine within the hinge of the Crown Reserve Anticline, which has been displaced from the Dufferin Mines to the south by the Harrigan Cove Fault. (b) Cross section of the Azure Resources Dufferin mine showing the distribution of 13 zones of saddle reefs inferred from diamond drilling.

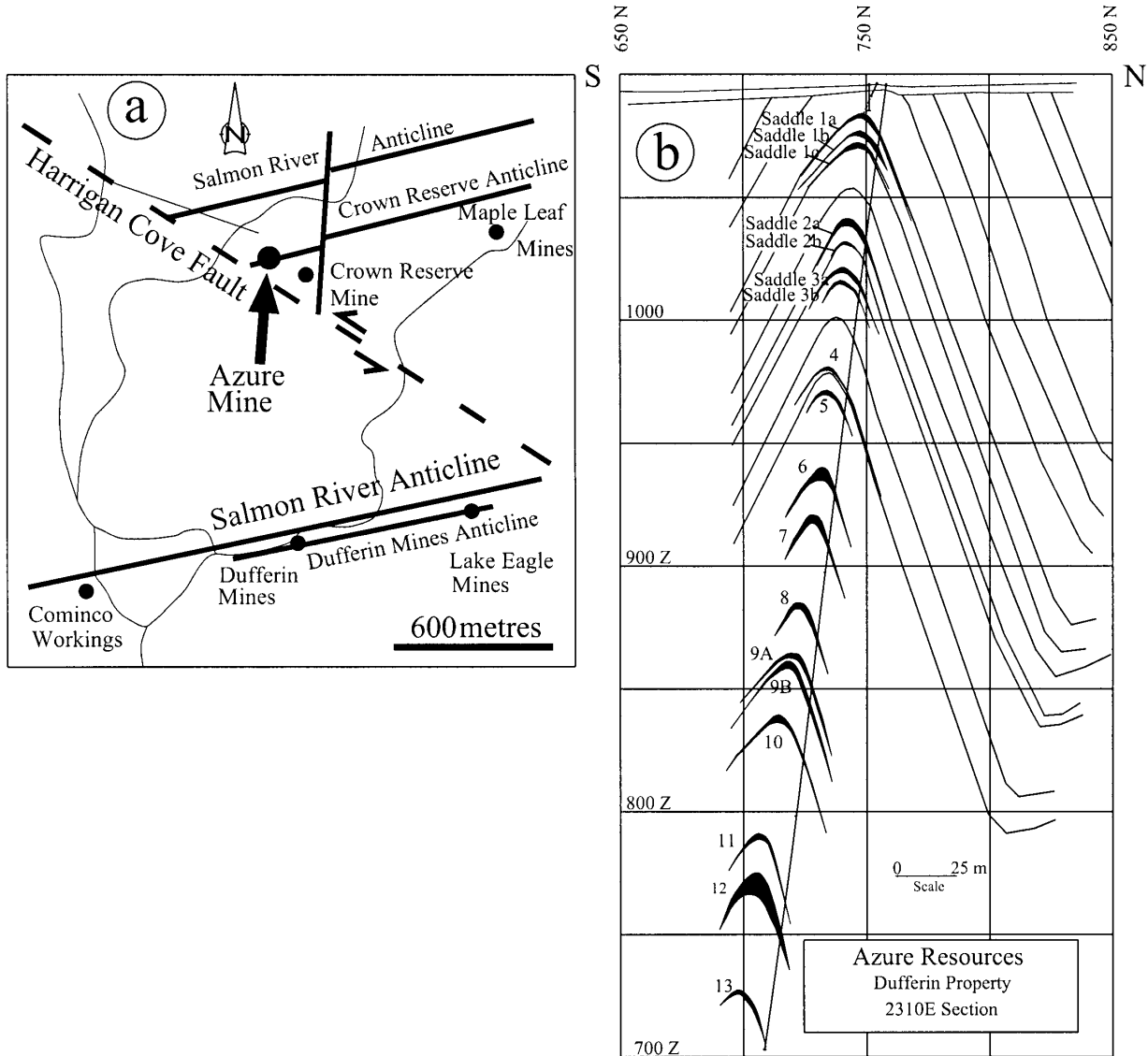
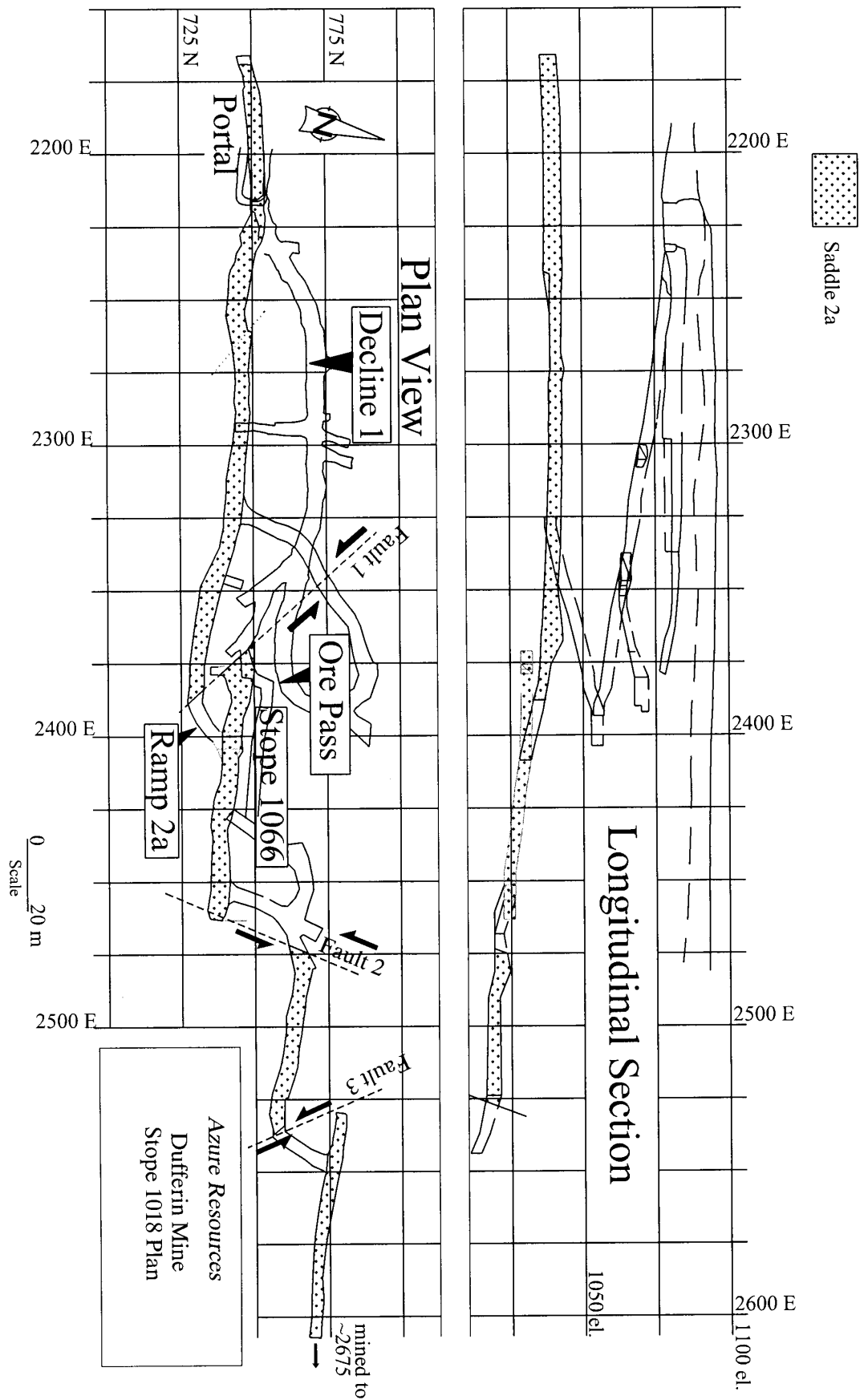

Figure 20: Plan and longitudinal projections of the underground working of the Azure Resources Dufferin mine. Underground stop locations are indicated.



remains thick down the north limb (left side) whereas the south limb tapers quickly down the south limb, where it is represented by a laminated vein. This asymmetric geometry of the saddle is repeated within all exposed saddles of the deposit.

A profile section exposed on the south limb at the portal entrance shows other bedding-concordant structures, including an echelon shear vein arrays and flexural-slip movement horizons. The laminated bedding-concordant vein extending down dip from the saddle vein is intersected by discordant cross veins.

### **Decline 1:**

This stop is about 40 metres down the main decline. At this location there is a laminated quartz vein exposed on the south (right) wall of the decline. The vein is not buckled, has a well developed fault gouge at its margin and has well developed down-dip striations on its margins and on the many internal laminations. Although the striations arguably postdate the vein, these striations likely record only the late movements of progressive flexural shear during which the vein was developed. This vein is auriferous, giving a value of +1oz/ton gold. This vein is structurally above any of the exposed saddle reefs but presumably represents the leg of an eroded saddle reef.

### **Stope 1066 - Ore Pass :**

Saddle 1a is exposed at this location and looks the same as at the portal. The asymmetry of the saddle is apparent, with development extending down the north leg (Fig. 21). The saddle is composite, consisting of mainly massive quartz with a laminated vein locally at the saddle margin (Fig 21). The laminated portion of the vein is invariably cut by massive quartz of the saddle and the laminated vein is tightly folded in the hinge area, but not on the limb. Discordant veins extend from the saddle vein into the footwall but not the hanging wall. Coarse gold occurs within the saddle vein and is generally accompanied by galena.

A profile of the south limb is exposed at the entrance of Stope 1066, which displays the south limb of the saddle, represented by a laminated vein, two bedding-concordant en echelon shear vein arrays and movement horizons represented by thin gouge (clay) intervals (Fig. 21). An ore pass extends from the 1066 stope into the main decline, exposing the north leg of the saddle. From the bottom of the ore pass, in the decline, the saddle can be seen to thin down dip, eventually being represented only by a laminated vein.

The distribution and character of saddle 1a exposed in stope 1066 and the ore pass is interpreted to reflect the following sequence: (1) formation of the laminated bedding-parallel vein, reflecting flexural slip (like at the Decline 1 stop); (2) Buckling of the laminated vein in the hinge area, reflecting layer-parallel shortening of the hinge while flexural shear occurred on the limbs and; (3) formation of the massive saddle vein as a result of continued flexural shear. The massive saddle vein invariably cuts (post-dates) the laminated vein, perhaps suggesting separate vein forming events. However, the sequence of events proposed is entirely consistent with progressive vein development during fold development, with massive saddles forming only after sufficient folding has occurred.

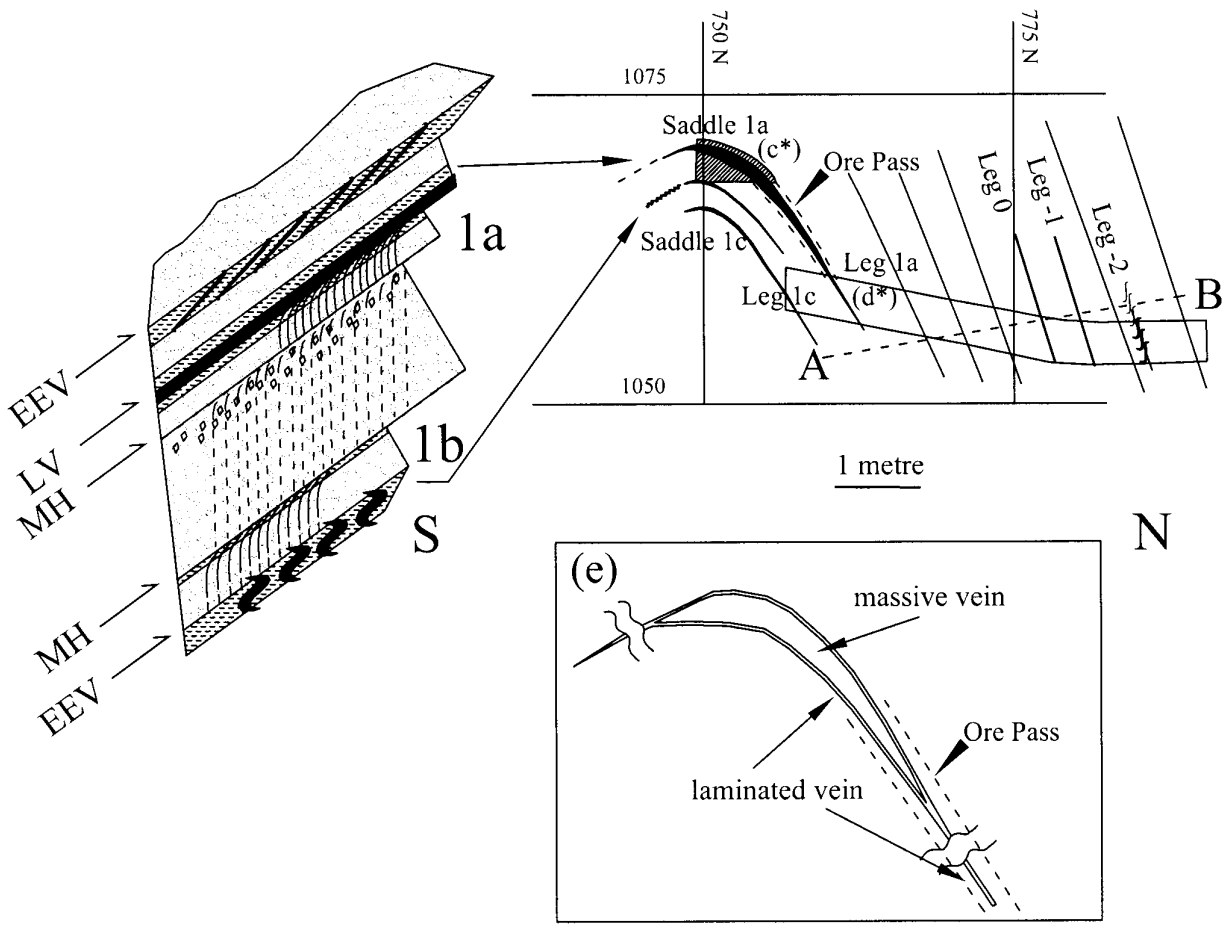

Figure 21: Cross section of Saddle 1 and structurally higher section of the north limb exposed in the decline. Detailed section at left shows detail of the stratigraphy and bedding-concordant movement horizons and en echelon veins associated with the south limb of the saddle as exposed in the 1066 stope. Lower figure, labeled (e), shows the geometry of the saddle and the distribution of laminated vein at the margin of the saddle.

### Ramp 2a:

Ramp 2a location is a short ramp which joins segments of saddle 2 across Fault 1 (Fig. 20). Fault 1 is obvious at the top of the ramp, where it cuts off Saddle 2a. The fault consists of a narrow movement horizon (few centimetres) with a wide zone (several metres) of intense kink fold development marginal to the fault. The southern limb of the fold structurally above Saddle 2a is exposed in the ramp. This section consists of sedimentary cycles dominated by metasandstone fining up into thin intervals of metasilstone-slate. Bedding-concordant structures reflecting flexural shear include en echelon vein arrays occurring across fine-grained intervals and movement horizons at the top of slate horizons (at the contact with overlying metasandstone) (Fig. 22).

## Ramp2a - South Limb

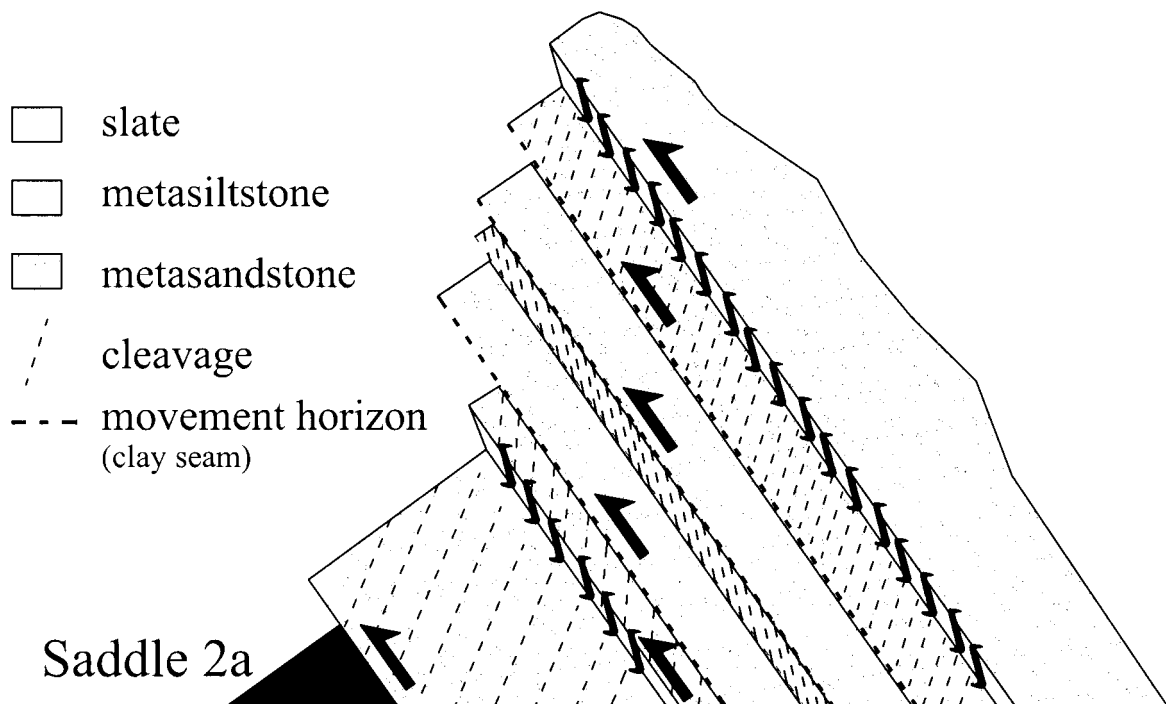

Figure 22: Profile section of the south limb above Saddle 2a exposed in the ramp across Fault 1, showing the stratigraphy and bedding-concordant structures recording flexural shear.



## REFERENCES

- Armstrong, P. 1937. The relationship of ore shoots to structure in the gold deposits of Nova Scotia. Nova Scotia Department of Natural Resources Open File Report ME-184.
- Bates, J.L.E. 1987. Gold in Nova Scotia. Nova Scotia Department of Mines and Energy, Information Series No. 13, 48p.
- Benn, K., Horne, R.J., Kontak, D.J., Pignotta, G. and Evans, N.G. 1997. Syntectonic emplacement of the South Mountain Batholith, Meguma Terrane, Nova Scotia: magnetic fabric and structural analysis. *Geological Society of America Bulletin* 109, 1279-1293.
- Cobbold, P.R., Cosgrove, J.W. and Summers, J.M., 1971. Development of internal structures in deformed anisotropic rocks. *Tectonophysics* 12, 23-53.
- Cosgrove, J.W. 1993. The interplay between fluids, folds and thrusts during deformation of a sedimentary succession. *Journal of Structural Geology* 15, 491-500.
- Culshaw, N. and Liesa, M. 1997. Alleghanian reactivation of the Acadian fold belt, Meguma Zone, southwest Nova Scotia. *Canadian Journal of Earth Sciences* 34, 833-847.
- Faribault, E.R. 1899. On the gold measures of Nova Scotia and deep mining. *The Canadian Mining Review* 18, no.3, 78-82.
- Faribault, E.R. 1902. Waverley, Canada Department of Mines, Geological Survey Branch, Map 67, scale 1:63,360.
- Faribault, E.R. 1913. The gold deposits of Nova Scotia. *The Canadian Mining Journal* 34, no.22, 108-109 and no.24, 780-781.
- Faribault, E.R. 1929. Bridgewater, Canada Department of Mines, Geological Survey Branch, Map 89, scale 1:63,360.
- Fletcher, H. and Faribault, E.R. 1911. Southeast Nova Scotia. Canada Department of Mines, Geological Survey, Map 53A, scale 1:250,000.
- Fitches, W.R., Cave, R., Craig, J. and Maltman, A.J. 1990. The flexural-slip mechanism: Discussion. *Journal of Structural Geology*, 12, p. 1081-1087.
- Fowler, T.J. 1996. Flexural slip generated bedding-parallel veins from central Victoria, Australia. *Journal of Structural Geology* 18, 1399-1415.

Fowler, T.J. and Winsor, C.N. 1996. Evolution of chevron folds by profile shape changes: comparison between multilayer deformation experiments and folds of the Bendigo-Castlemaine goldfields, Australia. *Tectonophysics* 258, 125-150.

Fowler, T.J. and Winsor, C.N. 1997. Characteristics and occurrence of bedding-parallel slip surfaces and laminated veins in chevron folds the Bendigo-Castlemaine goldfields: implications for flexural-slip folding. *Journal of Structural Geology* 19, 799-815.

Graves, M.C. and Zentilli, M. 1982. A review of the geology of gold in Nova Scotia: In: R.W. Hodder and K.W. Petruk (Eds.), *Geology of Canadian Gold Deposits*, Canadian Institute of Mining and Metallurgy, Special Volume 24, 233-242.

Haynes, S.J. 1986. Geology and geochemistry of turbidite-hosted gold deposits, greenschist facies, eastern Nova Scotia. In *Turbidite-hosted gold deposits*. Eds J.D. Keppie, R.W. Boyle and S.J. Haynes. Geological Association of Canada, Special Paper 32, p. 161-178.

Harper, C.L. 1988. On the nature of time in the cosmological perspective. Unpublished Ph.D. thesis, Oxford University.

Henderson, J.R. 1983. Analysis of structure as a factor controlling gold mineralization in Nova Scotia. In *Mines and Minerals Branch Report of Activities 1982*, Ed. K.A. Mills. Nova Scotia Department of Mines and Energy Report 83-1, p. 265-282.

Henderson, J.R. and Henderson, M.N. 1986. Constraints on the origin of gold in the Meguma Zone, Ecum Secum area, Nova Scotia. *Maritime Sediments and Atlantic Geology* 22, 1-13.

Henderson, J.R., Wright, T.O. and Henderson, M.N. 1986. A history of cleavage and folding: and example from the Goldenville Formation, Nova Scotia. *Geological Society of America* 97, 1354-1366.

Henderson, J.R. and Henderson, M.N. 1988. Meguma Gold Deposits: nested saddle reefs of early Hydraulic extension fractures? In *Mines and Minerals Branch Report of Activities 1987, Part A*, eds. J.L. Bates and D.R. MacDonald. Nova Scotia Department of Mines and Energy, Report 87-5, p. 213-215.

Henderson, J.R. and Henderson, M.N. 1990. Crack-seal texture in bedding-parallel, gold bearing columnar-quartz veins: evidence of fossil water sills. In: *Mineral Deposits of Nova Scotia*, Volume 1, ed. A.L. Sangster. Geological Survey of Canada, Paper 90-8, p. 163-168

Henderson, J.R., Henderson, M.N. and Wright, T.O. 1990. Water-sill hypothesis for the origin of certain veins in the Meguma Group, Nova Scotia, Canada. *Geology*, 18, p. 654-657.

Henderson, J., Wright, T. and Henderson, M. 1992. Strain history of the Meguma Group, Lunenburg and Ecum Secum areas, Nova Scotia. Geological Association of Canada,

Mineralogical Association of Canada Joint Annual Meeting, Wolfville, Nova Scotia; Field Excursion C-11: Guidebook.

Hicks, R.J., Jamieson, R.A. and Reynolds, P.H. 1999. Detrital and metamorphic  $^{40}\text{Ar}/^{39}\text{Ar}$  ages from muscovite and whole rock samples, Meguma Supergroup, southern Nova Scotia. *Canadian Journal of Earth Sciences* 36, 23-32.

Horne, R.J. 1998. An evaluation of flexural-slip folding in the Meguma Group, Halifax and Ovens areas, southern Nova Scotia. Unpublished M.Sc. thesis, Dalhousie University, Halifax, Nova Scotia.

Horne, R.J., Baker, D, Feetham, M. and MacDonald, L. 1997. Preliminary Geology of the Waverly - Halifax Airport area, central Nova Scotia: Some insights on the timing of deformation and vein formation in the Meguma Group. In Mineral and Energy Branch Report of Activities 2001, eds. D.R. MacDonald and K.A. Mills Nova Scotia Department of Natural Resources Report 97-1, p. 57-72

Horne, R.J., Covey, G. and Albert, C. 2004. Geological report on the early stages of development of the Mooseland Gold District (NTS 11D/15), Halifax County. In Mineral Resources Branch, Report of Activities 2003. Nova Scotia Department of Natural Resources Report 2004-1, p. 25-39.

Horne, R.J. and Culshaw, N. 2001. Flexural-slip folding in the Meguma Group, Nova Scotia Canada. *Journal of Structural Geology*, 23, p. 1631-1652.

Horne, R.J. and Jodrey, M. 2001. Geology of the Dufferin Gold Deposit (NTS 11D/16), Halifax County. In Mineral and Energy Branch Report of Activities 2001, ed. D.R. MacDonald. Nova Scotia Department of Natural Resources Report ME 2002-1, p. 51-67.

Horne, R.J., MacDonald, M.A., Corey, M. and Ham, L. 1992. Structure and emplacement of the South Mountain Batholith. *Atlantic Geology*, 28, 29-50.

Keppie, J.D. 1976. Structural model for the saddle reef and associated gold veins in the Meguma Group, Nova Scotia. *Canadian Institute of Mining and Metallurgy Transactions* 69, 103-116.

Keppie, J.D., Haynes, S.J., Henderson, J.R., Smith, P.K., O'Brien, B.H., Zentilli, M, Jenson, L.R, MacEachren, I.J., Stea, R and Rogers, P. 1983. CIM Geology Division, Excursion Guidebook. Gold Deposits in the Meguma Terrane of Nova Scotia.

Kontak, D.J., Horne, R.J., Sandeman, H., Archibald, D. and Lee, J.K.W. 1998.  $^{40}\text{Ar}/^{39}\text{Ar}$  dating of ribbon-textured veins and wall rock material from Meguma lode gold deposits, Nova Scotia: Implications for timing and duration of vein formation in slate-belt hosted vein gold deposits. *Canadian Journal of Earth Sciences* 35, 746-761.

- Kontak, D.J., Smith, P.K., Kerrich, R. and Williams, P.F. 1990a. Integrated model for Meguma Group lode gold deposits, Nova Scotia, Canada. *Geology* 18, 238-242.
- Kontak, D.J., Smith, P.K., Reynolds, P. and Taylor, K. 1990b. Geological and  $^{40}\text{Ar}/^{39}\text{Ar}$  constraints on the timing of quartz vein formation in the Meguma Group lode-gold deposits, Nova Scotia. *Atlantic Geology* 26, 201-277.
- Malcom, W. 1929. Gold Fields of Nova Scotia. Geological Survey of Canada, Memoir 385.
- Mawer, C.K. 1987. Mechanics of formation of gold-bearing quartz veins, Nova Scotia, Canada. *Tectonophysics* 135, 99-119.
- McKinstry, H.E. and Ohle, E.L. 1949. Ribbon Structure in Gold-Quartz Veins. *Economic Geology*, 44, p. 87-109.
- Melvin, A.E. 1987. Vein - host rock relationships in the Mooseland Gold District of the Meguma Group. Unpublished BSc thesis, St Francis Xavier University, Antigonish, Nova Scotia, 86p.
- Newhouse, W.H. 1936. A zonal gold mineralization, Nova Scotia. *Economic Geology*, 31, p. 805-831.
- Ramsay, J.G. 1967. *Folding and Fracturing of Rocks*. McGraw-Hill, New York.
- Ramsay, J.G. 1974. Development of chevron folds. *Geological Society of America Bulletin* 85, 1741-1754. Ramsay, J.G. and Huber, M.I. 1983. *The techniques of Modern Structural Geology, Volume 1: Strain Analysis*. Academic Press, London.
- Ramsay, J.G. 1980. Shear zone geometry: a review. *Journal of Structural Geology*, 2, p. 83-99.
- Ramsay, J.G. and Huber, M.I. 1987. *The techniques of Modern Structural Geology, Volume 2: Folds and Fractures*. Academic Press, London.
- Sangster, A.L. 1990. Metallogeny of the Meguma Terrane, Nova Scotia. In: A.L. Sangster (Ed.), *Mineral Deposits of Nova Scotia, Volume 1*. Geological Survey of Canada, Paper 90-8, 115-162.
- Smith, P.K. 1976. The structural geology of the south-eastern part of the Kentville area (21H/2E), Nova Scotia. Unpublished M.Sc. thesis, Acadia University, Wolfville, Nova Scotia, Canada.
- Smith, P.K. and Kontak, D.J. 1988. Meguma Gold Studies II: Vein morphology, classification and information, a new interpretation of "crack seal" quartz veins. In *Mines and Minerals Branch Report of Activities 1987, Part B*, Eds. D.R. MacDonald and Y Brown. Nova Scotia Department of Mines and Energy Report 88-1, p. 61-76.

Stea, R.R. and Pullan, S. 2001. Hidden Cretaceous basins in Nova Scotia, Canadian Journal of Earth Sciences, 38, p. 1335-1354.

Stone, J.B. 1932. The Structural Environment of the Bendigo Goldfield. Economic Geology, 32, p. 867-895.

Tanner, P.W.J. 1989. The flexural slip mechanism. Journal of Structural Geology 11, 635-655.

Williams, P.F. and Hy, C. 1990. Origin and deformational and metamorphic history of gold-bearing quartz veins on the Eastern Shore of Nova Scotia. In: A.L. Sangster (Ed.), Mineral Deposits of Nova Scotia, Volume 1. Geological Survey of Canada, Paper 90-8, 169-194.

Wright, T.O. and Henderson, J.R. 1992. Volume loss during cleavage formation in the Meguma Group, Nova Scotia, Canada. Journal of Structural Geology, 14, p. 281-290.

Young, M. 2000. Minor folds in coticule layers and their relationship to regional fold evolution, central Meguma Terrane, Nova Scotia. Unpublished B.Sc. thesis, Dalhousie University, Halifax Nova Scotia, 146p.

## PRE-CONFERENCE FIELD TRIPS

- A1** Contamination in the South Mountain Batholith and Port Mouton Pluton, southern Nova Scotia  
*D. Barrie Clarke and Saskia Erdmann*
- A2** Salt tectonics and sedimentation in western Cape Breton Island, Nova Scotia  
*Ian Davison and Chris Jauer*
- A3** Glaciation and landscapes of the Halifax region, Nova Scotia  
*Ralph Stea and John Gosse*
- A4** Structural geology and vein arrays of lode gold deposits, Meguma terrane, Nova Scotia  
*Rick Horne*
- A5** Facies heterogeneity in lacustrine basins: the transtensional Moncton Basin (Mississippian) and extensional Fundy Basin (Triassic-Jurassic), New Brunswick and Nova Scotia  
*David Keighley and David E. Brown*
- A6** Geological setting of intrusion-related gold mineralization in southwestern New Brunswick  
*Kathleen Thorne, Malcolm McLeod, Les Fyffe, and David Lentz*
- A7** The Triassic-Jurassic faunal and floral transition in the Fundy Basin, Nova Scotia  
*Paul Olsen, Jessica Whiteside, and Tim Fedak*

## POST-CONFERENCE FIELD TRIPS

- B1** Accretion of peri-Gondwanan terranes, northern mainland Nova Scotia and southern New Brunswick  
*Sandra Barr, Susan Johnson, Brendan Murphy, Georgia Pe-Piper, David Piper, and Chris White*
- B2** The Joggins Cliffs of Nova Scotia: Lyell & Co's "Coal Age Galapagos"  
*J.H. Calder, M.R. Gibling, and M.C. Rygel*
- B3** Geology and volcanology of the Jurassic North Mountain Basalt, southern Nova Scotia  
*Dan Kontak, Jarda Dostal, and John Greenough*
- B4** Stratigraphic setting of base-metal deposits in the Bathurst Mining Camp, New Brunswick  
*Steve McCutcheon, Jim Walker, Pierre Bernard, David Lentz, Warna Downey, and Sean McClenaghan*
- B5** Geology and environmental geochemistry of lode gold deposits in Nova Scotia  
*Paul Smith, Michael Parsons, and Terry Goodwin*
- B6** The macrotidal environment of the Minas Basin, Nova Scotia: sedimentology, morphology, and human impact  
*Ian Spooner, Andrew MacRae, and Danika van Proosdij*
- B7** Transpression and transtension along a continental transform fault: Minas Fault Zone, Nova Scotia  
*John W.F. Waldron, Joseph Clancy White, Elizabeth MacInnes, and Carlos G. Roselli*
- B8** New Brunswick Appalachian transect: Bedrock and Quaternary geology of the Mount Carleton – Restigouche River area  
*Reginald A. Wilson, Michael A. Parkhill, and Jeffrey I. Carroll*
- B9** Gold metallogeny in the Newfoundland Appalachians  
*Andrew Kerr, Richard J. Wardle, Sean J. O'Brien, David W. Evans, and Gerald C. Squires*